

# SLIPSIL® SEALING PLUGS FOR CABLE AND PIPE PENETRATIONS: OPTIMUM FIRE SAFETY GAS AND WATERTIGHT



**SUCCESSFULLY TESTED ACCORDING TO  
EN 1366-3:2004; FIRE RESISTANCE  
E190/E120 ACCORDING TO EN 13501-2:2003  
CERTIFICATE 2007-EFECTIS-R0764**



# MAXIMUM SIMPLICITY OF USE OPTIMUM FLEXIBILITY OUTSTANDING PERFORMANCE

Websites: <http://www.actifoam.com>, [www.beele.com](http://www.beele.com), [www.firsto.com](http://www.firsto.com), [www.nofirno.com](http://www.nofirno.com),  
[www.rise-systems.com](http://www.rise-systems.com), [www.rise-nofirno.com](http://www.rise-nofirno.com), [www.riswat.com](http://www.riswat.com) and [www.slipsil.com](http://www.slipsil.com)

<b>Copyright</b>	: BEELE Engineering BV/CSD International BV, Aalten, the Netherlands. Proprietary rights on all drawings and technical data released in this brochure. © 1997-2009
<b>Edition</b>	: May 2009
<b>Note</b>	: No part of this publication may be reproduced without explicit written approval of BEELE Engineering BV.
<b>Research &amp; Development</b>	: BEELE Engineering BV, Aalten, the Netherlands.
<b>Note</b>	: The manufacturer reserves the right to make dimensional and design modifications without prior notification.
<b>®</b>	: <b>ACTIFIRE, ACTIFOAM, AQUASTOP, BEEBLOCK, BEELE, BEESEAL, CONDUCTON, CRUSHER, CSD, CSD THE SIMPLE SEAL SYSTEM, DRIFIL, DYNATITE, FIRSTO, FIRUB/NOHAL, FITEFIRE, FIWA, FRR, LEAXEAL, LUMIREFLEC, MULTI-ALL-MIX, NOFIRNO, RAPID TRANSIT SYSTEM, RIACNOF, RISE, RISWAT, S, SLIPSIL, flanges SLIPSIL plugs, ULEPSI and YFESTOS</b> are registered trade marks of BEELE Engineering BV.
<b>brochure code</b>	: SLIPSIL/hb/en/con

# BEELE ENGINEERING BV CSD INTERNATIONAL BV

BEELE Engineering and CSD International have been working in the field of water and gas tight and fireproof sealing of conduits for pipes and cables for more than 35 years. In the field of passive fire prevention, we have invested substantial amounts of money in the development of systems which are capable withstanding fires for extended periods of time. Passive fire prevention is a very complicated matter due to the fact that cable and pipe penetrations have to be designed to the actual circumstances at site and not for a laboratory test. In case of a catastrophe penetrations are subject not only to flame erosion and very high temperatures, but also

to mechanical loads due to collapsing cableways and possibly a jet of fire-fighting water. This means that the performance in actual situations can differ dramatically from that in a regular fire test. In fact, the systems could only be applied as tested to guarantee the required fire safety.

## **And this means discussions and limitations!**

We have ensured that our systems will function under all circumstances, and the classification societies have awarded us signed and stamped installation drawings of our sealing systems. Approved for steel and aluminium partitions. Guaranteed safety in your installation will be the result.

*The R&D department of BEELE Engineering is constantly working in the field of rubber and systems techniques to optimize the existing systems and to develop new concepts for cable and pipe conduits on board of vessels and offshore installations. Although installation of the CSD sealing systems is in fact an easy matter, a full training programme can be given in-house by our engineers. Because the advantages and possibilities of passive fire prevention and evacuation signposting can most effectively be discovered in an environment that matches the practical situation as closely as possible, we have constructed an unique research and development centre. As far is known, this R&D centre is the only institute world-wide where visitors can experience for themselves all the aspects of fire prevention and evacuation signposting systems.*



Above an impression of the research and development centre with a training and schooling institute for passive fire prevention products and systems and for the improvement of evacuation signposting systems in buildings and on board ships. The centre consists of a presentation theatre seating up to 45 persons, and a mock-up covering about 500 square metres in which various evacuation signposting systems are installed to enable their effectiveness to be

determined in the dark.

The behaviour of escaping persons inside the test facility is recorded from a separate technical area (with an associated showroom) by means of infra-red cameras and an audio-video system.

In addition the centre comprises three laboratories with a total surface area of about 300 square metres in which, respectively, large-scale fire tests, mechanical tests, and light emission investigations are performed.

# SLIPSIL® SEALING PLUGS: HIGH-TECH NOFIRNO® TECHNOLOGY

# slipsil

**LUBRICATE AND PUSH:  
THE PLUG SLIDES IN**



## BENEFITS of SLIPSIL® plugs:

IN A WAY THE USE OF SLIPSIL® SEALING PLUGS IS AN ADVANTAGE FOR THE BUILDER, THE INSTALLER AND THE OWNER OF THE INSTALLATION.

THE CONTRACTOR CAN SAVE QUITE SOME TIME DUE TO THE AVAILABILITY OF FITTING EMBEDDED PIPES FOR SLIPSIL® PLUGS AND ALSO BECAUSE OF THE FACT THAT SLIPSIL® PLUGS CAN BE APPLIED IN DRILLED HOLES. INNOVATIVE DESIGN: THE PLUG SEALING SYSTEM ALLOWS THE SHORTEST POSSIBLE CONDUIT LENGTH FOR FIRE RATED PENETRATIONS. SLIPSIL® PLUGS CAN BE USED FOR ALL TYPES OF METALLIC AND PLASTIC PIPES! FOR THE INSTALLER IT IS MOST ADVANTAGEOUS THAT THE PLUGS CAN BE INSTALLED IN MINUTES AND DO NOT REQUIRE ANY BOLTING OR OTHER MECHANICAL OUTFITTING. FOR THE OWNER THE SAVINGS ARE IN THE FIELD OF MAINTENANCE COSTS DUE TO THE EXCLUSION OF MECHANICAL STRESSES AND AVOIDING CORROSION PROBLEMS.

# **SLIPSIL<sup>®</sup> SEALING PLUGS: HIGH-TECH NOFIRNO<sup>®</sup> TECHNOLOGY**

- \* ONE RUBBER TYPE FOR MOST APPLICATIONS
- \* CLEARLY RECOGNIZABLE DESIGN AND COLOUR
- \* EASY INSPECTION: ALLOWABLE OD OF SERVICE PIPE MARKED ON FLANGE
- \* 10% MORE OF SUPERIOR NOFIRNO<sup>®</sup> RUBBER COMPARED TO CSD
- \* EXTENDED SERVICE LIFE OF OVER 20 YEARS NOFIRNO<sup>®</sup> RUBBER
- \* MAINTENANCE FRIENDLY
- \* NO METAL PARTS, NO CORROSION
- \* NO COMPRESSION NEEDED, LESS PERMANENT DEFORMATION
- \* ENORMOUS WEIGHT SAVINGS VERSUS FLANGING METHODS
- \* LONG LASTING FLEXIBLE SYSTEM: NO MECHANICAL STRESSES TRANSFERRED TO THE CONSTRUCTION
- \* PROVIDES CATHODIC PROTECTION
- \* MOST EASY TO INSTALL: REDUCED LABOUR COSTS
- \* SHORTEST POSSIBLE CONDUIT LENGTH, LESS INSULATION
- \* HIGH PERFORMANCE: FIRE SAFE, GAS AND WATER TIGHT
- \* VERY WIDE TEMPERATURE RANGE FOR SEALING CONDUITS OF FREON PIPES UP TO STEAM LINES
- \* TEMPERATURE CHANGES ARE EASILY ABSORBED
- \* AN EMC PROTECTIVE SOLUTION IS INCORPORATED
- \* VIBRATION PROOF/SOUND DAMPENING
- \* EC (MED) AND TYPE APPROVAL CERTIFICATES ISSUED
- \* CLASS SOCIETY STAMPED INSTALLATION DRAWINGS ENSURE PRODUCT IS INSTALLED AS APPROVED
- \* FOR STEEL, STAINLESS STEEL, COPPER, GRP AND PLASTIC PIPES
- \* APPROVED FOR STEEL AND ALUMINIUM PARTITIONS

# SLIPSIL® SEALING PLUGS: HIGH-TECH NOFIRNO® TECHNOLOGY

The new generation SLIPSIL® sealing plugs offers a substantial technical improvement with regard to installation, sealing capacity, ageing aspects and long term performance. Numerous tests have been carried out proving that - provided the plugs are sufficiently lubricated and dimensions of conduit and service pipe are nominal - most of the plugs can be installed just by hand.

This has been made possible by an engineered design of the inside and outside profiling of SLIPSIL® plugs.

## **LUBRICATE AND PUSH: THE PLUG SLIDES IN**

The SLIPSIL® plugs have an aesthetic and well recognizable appearance. The plugs are clearly marked with the CSD® logo and the SLIPSIL® mark on the flange. Extra feature for recognition is the shape of the flange. The specific terracotta colour of the SLIPSIL® plugs is unique for this product line. In this way the origin of the sealing plug can easily be determined, even after installation.



## **SLIPSIL® SEALING PLUGS ARE OF HIGHEST QUALITY**

For manufacturing SLIPSIL® plugs use is made of a high quality rubber grade.

NOFIRNO® rubber has excellent weathering properties, UV and ozone resistance and long term behaviour. Service life of the plugs easily exceeds 50 years under normal environmental conditions. The plugs can be used in a very wide temperature range. Even at low temperatures down to -50° C the rubber stays flexible and does not harden excessively as other rubber types will do. This guarantees tightness even at low temperatures.

The rubber can also be used in applications up to +180° C.

***A single rubber grade is now capable of satisfying almost all sealing conditions.***

Sealing systems are safety devices. Only highest quality can do the job, not only when newly installed but also after a long service life. With SLIPSIL® plugs this safety is guaranteed for a very long time!

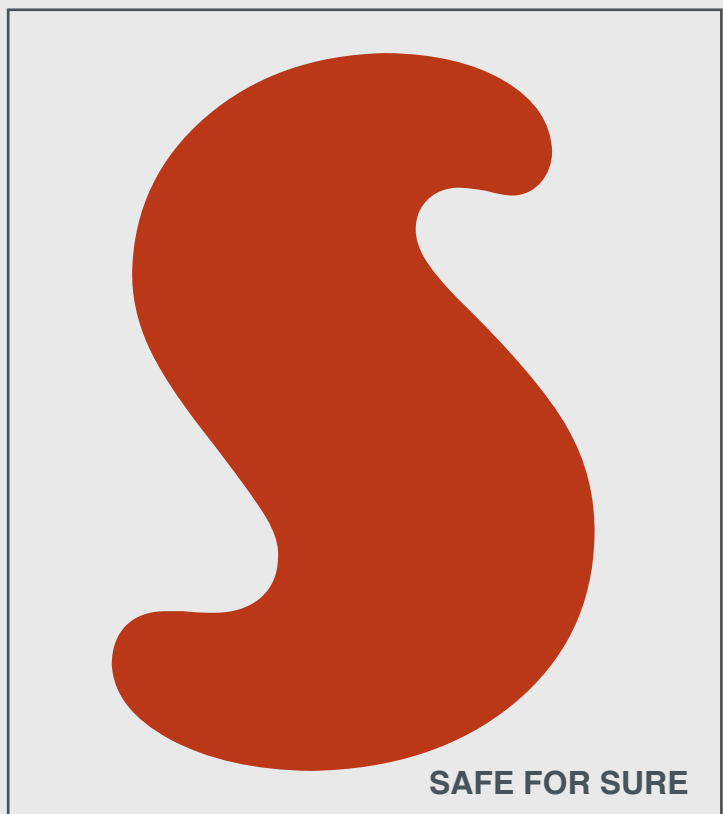

**SLIPSIL® sealing plugs are made of NOFIRNO® fire resistant rubber, our most superior rubber grade. This rubber is compounded under special conditions in our factory to obtain the outstanding properties for use in a wide variety of applications.**

# SLIPSIL® SEALING PLUGS: HIGH-TECH NOFIRNO® TECHNOLOGY

## **LUBRICATE AND PUSH: THE PLUG SLIDES IN**

A new design of the well-known CSD® plugs has been developed by the engineers of BEELE Engineering. Rubber engineering expertise and 35 years practical experience with sealing systems have contributed to an excellent product.

In view of the incompressibility of rubbers, the design work focused on finding an ideal solution to allow rubber to move in the right directions under mechanical loads.

Furthermore a high grade flexible rubber with outstanding long term behaviour is used for SLIPSIL® plugs.

Extensive testing in our R&D centre under survey of an independent organization took place to determine the properties. The tests found that the new SLIPSIL® plugs are indeed easy to install, that tightness has been improved substantially and that also the flexibility of the rubber is of such a level that vibrations easily are absorbed.



Our most superior rubber grade, which is suitable for gas and water tight ducting and for fire rated applications as well, has been selected for SLIPSIL® plugs.

For decades we have been involved with fire resistant rubbers. The drawbacks of certain fire resistant types are halogen content, hardness of the highly filled rubbers, hardening during lifetime and high permanent deformation sets. All these features will have an impact on performance in the long run. NOFIRNO® rubber does not have the above drawbacks.

Not only the selection of the rubber polymer and additives is determining. The processing conditions for optimized compounding in our factory assure highest performance of the rubber.

### **NOFIRNO® rubber:**

#### **highest quality with traceability**

NOFIRNO® rubber is traceable to prevent counterfeiting and to guarantee users that they get the BEELE quality they are paying for.



**SLIPSIL® sealing plugs are made of NOFIRNO® rubber which will not be consumed in fire conditions. From the way of surface charring and the rubber residues inside the product, it can easily be determined whether or not NOFIRNO® has been used.**

# SLIPSIL® SEALING PLUGS: HIGH-TECH NOFIRNO® TECHNOLOGY

## **LUBRICATE AND PUSH: THE PLUG SLIDES IN**

Sealing plugs are used to obtain a certain degree of gas and water tightness. Water leaks will be noticed rapidly. Gas leaks, however, are not visible and might be more dangerous. Tightness is dependent on quite a number of parameters. From the design and material point of view, this means that properties have to be incorporated in the design to exclude failures as far as possible. This starts with the way of installation and ends with long term performance.

The designers of the SLIPSIL® plug have been focusing on this issue. An appropriate profiling design and the use of a rubber grade with a proper flexibility, hardness and compression set offer excellent long term behaviour. The leveled outside profiles of the plug secure a proper surface contact inside the conduit and finally the inner ribs have a “sliding” design, not only for ease of installation, but also to create sufficient grip.

*Quality System Approval  
SMS.W.I.CE.D/2357/A.0 and ISO  
9001:2001 Certificate NL7001684  
issued by Bureau Veritas*

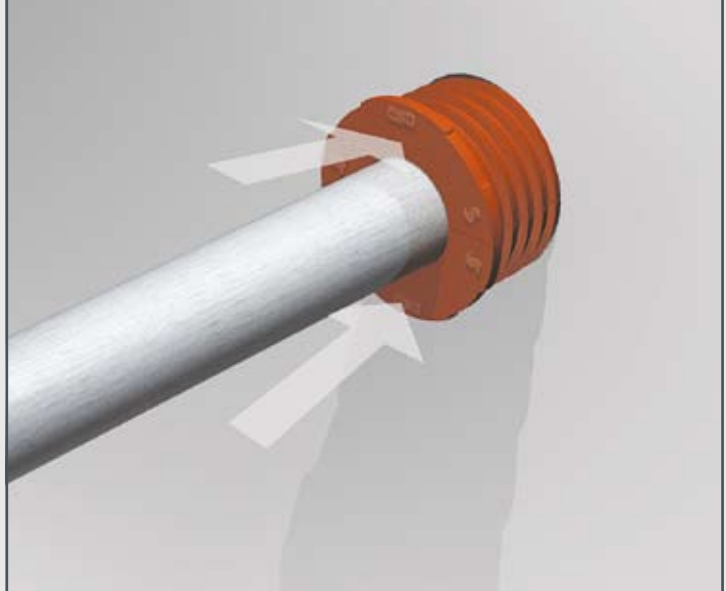

## **SLIPSIL® PLUGS : TESTED IN EXTREME TOLERANCES**

It will be obvious that one pressure test in a laboratory under controlled conditions will not be sufficient to claim a tightness for a complete range with varying tolerances.

For each series, three pressure tests at nominal dimensions are required to determine the pressure ratings for plugs with smallest, medium and largest inlet. These plugs also have to be subjected to three pressure tests with the minimum pipe diameter and the widest conduit opening to determine tightness in extreme tolerances. Then the procedure has to be repeated with the smallest conduit size and the largest pipe diameter to determine ease of installation. Finally the largest pipe diameter has to be tested in the widest conduit opening to determine tightness in another extreme condition.

Conclusion: a total of twelve pressure tests for each series to determine the operational tolerances and ease of installation.



**All these tests have been carried out in our laboratory under survey of an independent institute. Conditioned processing of NOFIRNO® rubber assures optimized compression set and hardness within very narrow tolerances of the vulcanized rubber.**



# SLIPSIL® SEALING PLUGS: HIGH-TECH NOFIRNO® TECHNOLOGY

## **AQUASTOP®: TECHNOLOGY FOR OPTIMUM TIGHTNESS**

SLIPSIL® plugs can be exposed to fairly high pressure loads directly after installation.

An average pressure rating has to be determined since it makes quite a difference whether a plug is tested with a small diameter pipe or with a large diameter pipe; or with a narrow or a wide conduit. Ratings are also different when pressurizing at the bottom side or on the flanged side.

For optimum tightness in the long term, the design and position of the profiles on the plugs is a determining factor.

Also the quality of the used polymer and the hardness and compression set of the vulcanized rubber is most important.

During testing it was noticed that SLIPSIL® plugs hold tight even on two serrated profiles.

See photograph below.

Clearly visible is the superb flexibility of the rubber.

A BEELE/CSD development!

## **AQUASTOP**



# SLIPSIL® SEALING PLUGS: HIGH-TECH NOFIRNO® TECHNOLOGY

## **FIRE SAFETY WITHOUT ANY EXTRAS - NOW ACHIEVABLE**

Synthetic rubbers are combustible. Rubber grades can be made only more or less fire retardant with the help of fire suppressant ingredients. The drawback of filling rubbers with large amounts of additives is that the mechanical properties might suffer.

The hardness of the vulcanized products of such compounds might be reasonably high. Both features have an impact on the sealing capacity and the long term behaviour.

Hardening and permanent deformation of the product during service life also have a negative impact on performance.

NOFIRNO® rubber is halogen free, does not harden during service life, has outstanding weathering properties, does not shrink during fire exposure, has an oxygen index of 55% (>30% is flame retardant) and a low smoke index. NOFIRNO® rubber can be used in a very wide temperature range.

Optimum fire safety guaranteed.

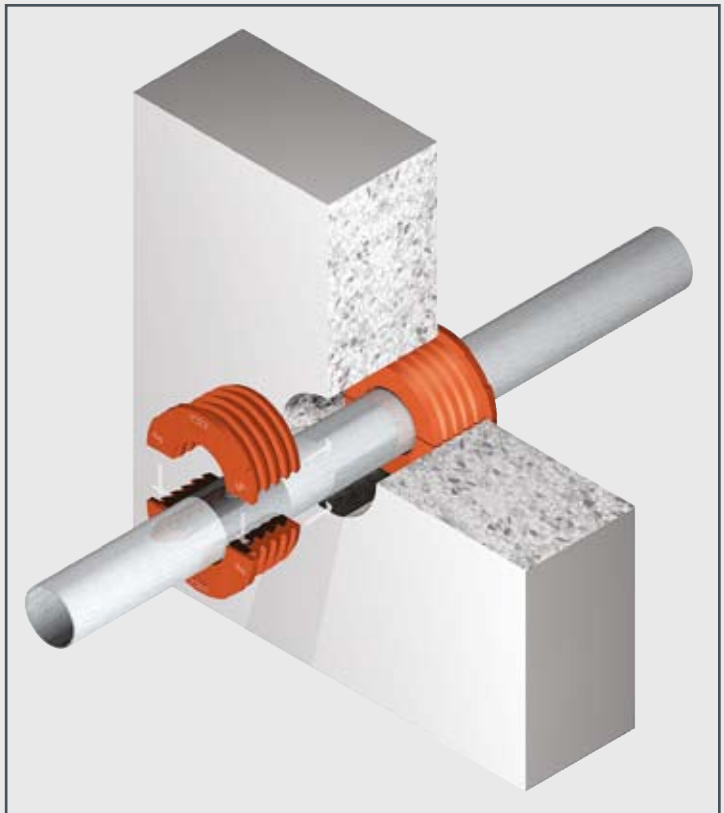

Our R&D engineers have put a lot of work into studying the regulations and the fire testing protocols. This knowledge has been the foundation of the development of systems capable of withstanding fire loads under most severe conditions without additional provisions. Fire retardant rubbers should be able to cope with fire exposure and thermal loads and this has to be proven.

SLIPSIL® plugs made of NOFIRNO® rubber have been tested without any insulation at the exposed side to deliver this proof.

## **SLIPSIL® HAS BEEN TESTED UNDER WORST CONDITIONS**

The numerous fire tests we have carried out with NOFIRNO® rubber plugs have shown that the rubber is able to withstand fire and thermal loads without showing any dramatic colour change or carbonization at the unexposed side. At the exposed side the rubber will NOT be consumed by the fire due to the protective layer and char formed. This means that the plug stays in place there.



**Our R&D engineers have developed a system technology on the basis of which an air cavity of only 10-20 mm between the plugs is sufficient to obtain the required thermal insulation under fire load. This means that the conduit length is substantially reduced.**

# SLIPSIL® SEALING PLUGS: HIGH-TECH NOFIRNO® TECHNOLOGY

## **NOFIRNO®: TECHNOLOGY FOR OPTIMUM FIRE SAFETY**

NOFIRNO® rubber can be exposed to fire without being seriously affected. The photographs on this page were made during a fire test on a non-insulated partition with a penetration intended for a highly combustible plastic pipe. The pipe could not handle the radiation heat of the red glowing steel deck and collapsed. This caused a fire on top of the sealing plug made of the NOFIRNO® rubber.

As explained previously, the rubber will immediately form a protective layer. This is the white colour visible on the photograph.

After the fire had been extinguished and the protective layer was scratched away, the original colour of the rubber became visible as if nothing had happened! On the plug at the fire side, a protective layer and a char underneath had formed. After the one hour fire test, the inside of the plug was found to be still terracotta coloured. See below. A BEELE/CSD development!



# NOFIRNO



# SLIPSIL® SEALING PLUGS: HIGH-TECH NOFIRNO® TECHNOLOGY

# slipsil

**LUBRICATE AND PUSH:  
THE PLUG SLIDES IN**

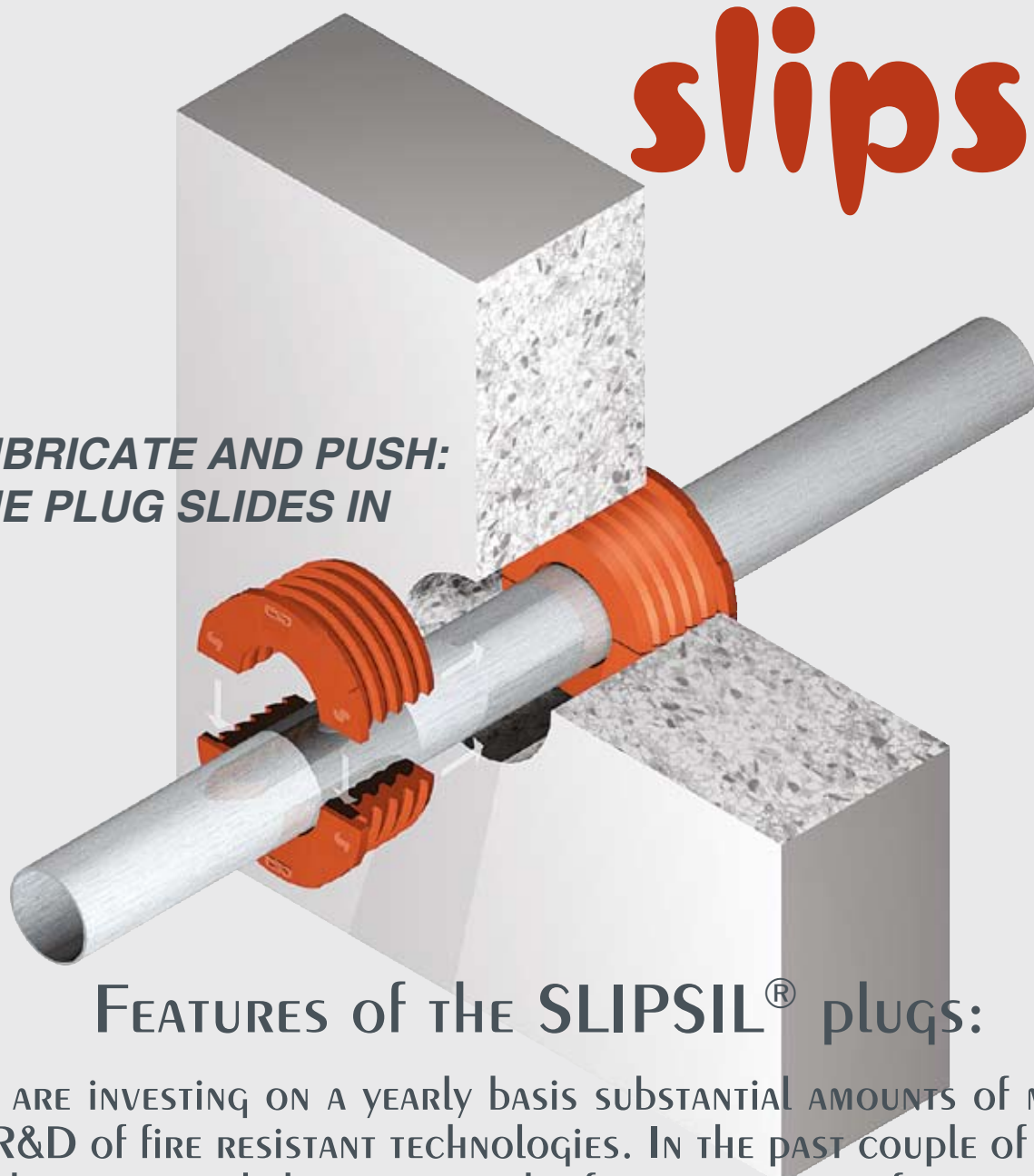

## FEATURES OF THE SLIPSIL® PLUGS:

WE ARE INVESTING ON A YEARLY BASIS SUBSTANTIAL AMOUNTS OF MONEY IN R&D OF FIRE RESISTANT TECHNOLOGIES. IN THE PAST COUPLE OF YEARS WE HAVE SUCCEEDED IN RAISING THE FIRE RESISTANCE OF OUR RUBBER COMPOUNDS TO THE HIGHEST LEVEL. TO AVOID ANY CONFUSION ON THE MARKET PLACE WE HAVE DESIGNED THE FLANGE OF SLIPSIL® SEALING PLUGS IN SUCH AN UNIQUE WAY THAT, EVEN AFTER INSTALLATION, THE PLUGS ARE EASY TO RECOGNIZE. WE HAVE ALSO MADE THE TERRACOTTA COLOUR OF SLIPSIL® SEALING PLUGS (AND ALL OTHER NOFIRNO® PRODUCTS) VERY DISTINCTIVE. SLIPSIL® PLUGS HAVE A VERY SPECIAL PROFILING ON THE OUTSIDE AND THE INSIDE. THE SERRATED PROFILES AT THE OUTSIDE HAVE AN INTERSPACING AND ARE LEVELED; THE INNER RIBS ARE FLATTENED AND INTERCONNECTED. UNIQUE FOR SLIPSIL® SEALING PLUGS AND THEREFORE EASY TO RECOGNIZE.

# SLIPSIL® SEALING PLUGS: HIGH-TECH NOFIRNO® TECHNOLOGY



EC (MED) certificates according to EUROPEAN UNION COUNCIL DIRECTIVE 96/98 EC on MARINE EQUIPMENT have been issued by Det Norske Veritas certificates N° MED-B-4906 for RISE/ULTRA, N° MED-B-4908 for RISE/NOFIRNO multi-pipe and multi-all-mix penetrations and N° MED-B-4941 for SLIPSIL plugs and by Bureau Veritas certificates N° 09156/B2 EC for RISE, RISE/NOFIRNO and RIACNOF multi-cable penetrations and extended multi-cable penetrations, N° 11301/B0 EC for RISE-EMC multi-cable penetrations, N° 11302/A2 EC for RISE busbar penetrations and certificates N° 10035/B0 EC and N° 10710/B1 EC for RISE single and multi-pipe penetrations for metallic and plastic pipes.

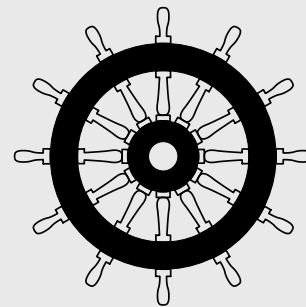

AMERICAN BUREAU of SHIPPING  
 BUREAU VERITAS  
 CHINA CLASSIFICATION SOCIETY  
 CHINA CORPORATION REGISTER of SHIPPING  
 DET NORSKE VERITAS  
 GERMANISCHER Lloyd  
 KOREAN REGISTER of SHIPPING  
 Lloyd's REGISTER of SHIPPING  
 Nippon Kaiji Kyokai  
 RUSSIAN MARITIME REGISTER of SHIPPING  
 TRANSPORT CANADA via DNV CERTIFICATES  
 USCG via MED CERTIFICATES

**slipsil**

CERTIFIED BY  
 THE MAJOR  
 CLASSIFICATION  
 SOCIETIES

*Note: configurations may differ per classification society.*

# SLIPSIL® SEALING PLUGS: HIGH-TECH NOFIRNO® TECHNOLOGY

## OVERVIEW OF SERIES FOR SINGLE SEALING PLUGS

PLUG SERIES	CONDUIT OPENING	PLUG LENGTH	PIPE DIAMETER	COVERING CSD SERIES
25	24.5 - 25.6	54	5 - 12	25.6
27	26.5 - 27.6	54	5 - 15	27.3, 27.6
28	27.5 - 28.5	54	5 - 15	28.4
30	29.5 - 30.5	54	5 - 16	30
32	31.5 - 32.5	54	5 - 16	32
34	33.5 - 34.5	54	5 - 18	33.6
35	34.5 - 35.7	54	5 - 20	35, 35.7
37	36.5 - 37.7	54	5 - 20	36.5, 37.2
40	39.5 - 40.7	54	5 - 22	40
41	40.5 - 41.7	54	5 - 25	41.1, 41.6
43	42.5 - 43.7	54	5 - 28	43.6
50	49.5 - 50.7	66	10 - 32	50
53	52.0 - 53.7	66	10 - 34	52.5, 52.9, 53,7
55	54.0 - 55.7	66	10 - 34	54,5
57	56.0 - 57.7	66	14 - 40	57
60	59.0 - 60.7	66	14 - 40	60
62	61.0 - 62.7	66	14 - 40	62.3
67	66.0 - 67.7	66	22 - 50	67.1
68	67.0 - 68.7	66	22 - 50	67.9, 68.6
70	69.0 - 70.7	66	22 - 50	70
75	74.0 - 75.7	66	22 - 50	75
78	77.0 - 78.7	66	22 - 50	77.9
80	79.0 - 80.7	66	28 - 60	80, 80.7
82	81.0 - 82.7	66	28 - 60	81.7, 82.5
90	89.0 - 90.7	66	40 - 64	90
94	93.0 - 94.7	66	40 - 64	94
97	96.0 - 97.7	66	40 - 64	97,2
100	99.0 - 100.7	66	40 - 75	100
102	101.0 - 102.7	66	40 - 75	102.3
103	102.0 - 103.7	66	40 - 75	103.6
105	104.0 - 105.7	66	40 - 75	105.3
107	106.0 - 107.7	66	40 - 75	107.1
110	109.0 - 110.7	66	48 - 80	110
118	117.5 - 119.2	66	60 - 90	118.6
122	121.0 - 122.7	66	60 - 92	122.2
125	124.0 - 125.7	66	60 - 92	125
128	127.0 - 128.7	66	60 - 92	128.1
131	130.5 - 132.2	66	60 - 92	131.7
146	145.0 - 146.7	79	88 - 120	146.3
150	149.0 - 150.7	79	88 - 125	150
152	151.0 - 152.7	79	88 - 125	152
154	153.0 - 154.7	79	88 - 125	154.1
156	155.0 - 156.7	79	88 - 125	156.2
160	159.0 - 160.7	79	88 - 125	159.3, 160
190	189.0 - 190.7	79	110-160	190,2
200	199.0 - 200.7	79	110-160	200
203	202.0 - 203.7	79	110-168	202,7
207	206.0 - 207.7	79	110-168	207,3

To select the right type of sealing plug, look for the plug series to be used on the basis of the outer diameter of the service pipe. Then make a choice for the plug type in the table of the selected plug series.

For instance: a copper pipe of 42 mm OD has to be ducted. Select the plug series on the basis of the ID of the conduit sleeve to be used and the OD of the ducted pipe (67 up to 107 can be your choice). When a conduit sleeve 88.9x3.2 mm (ID = 82.5 mm) will be used a sealing plug 82/42-44 is the right choice. If a 54 mm OD copper pipe has to be ducted through a sleeve with an ID of 107.1 mm, plug type 107/54-56 has to be selected. See the tables of the series 82 and 107 on pages 18 and 20.

*Note: the sealing plugs with a thin wall (like for instance 53/34) are not easy to install in undersized conduit openings. It is advisable to select a larger plug series (for instance 60/34-36).*

# SLIPSIL® SEALING PLUGS: HIGH-TECH NOFIRNO® TECHNOLOGY

## TABLES FOR SINGLE SEALING PLUGS

cable/ pipe diameter	plug type	article number	plug length
blind	25/0	40.0100	54
5-6	25/5-6	40.0105	54
6-7	25/6-7	40.0106	54
7-8	25/7-8	40.0107	54
8-9	25/8-9	40.0108	54
9-10	25/9-10	40.0109	54
10-11	25/10-11	40.0110	54
11-12	25/11-12	40.0111	54
12	25/12	40.0112	54

COVERS CSD SERIES 25.6

**25 SERIES**  
ID CONDUIT OPENING 24.5-25.6 MM

cable/ pipe diameter	plug type	article number	plug length
blind	27/0	40.0200	54
5-6	27/5-6	40.0205	54
6-7	27/6-7	40.0206	54
7-8	27/7-8	40.0207	54
8-9	27/8-9	40.0208	54
9-10	27/9-10	40.0209	54
10-11	27/10-11	40.0210	54
11-12	27/11-12	40.0211	54
12-13	27/12-13	40.0212	54
13-14	27/13-14	40.0213	54
14-15	27/14-15	40.0214	54
15	27/15	40.0215	54

COVERS CSD SERIES 27.3, 27.6

**27 SERIES**  
ID CONDUIT OPENING 26.5-27.6 MM

cable/ pipe diameter	plug type	article number	plug length
blind	28/0	40.0300	54
5-6	28/5-6	40.0305	54
6-7	28/6-7	40.0306	54
7-8	28/7-8	40.0307	54
8-9	28/8-9	40.0308	54
9-10	28/9-10	40.0309	54
10-11	28/10-11	40.0310	54
11-12	28/11-12	40.0311	54
12-13	28/12-13	40.0312	54
13-14	28/13-14	40.0313	54
14-15	28/14-15	40.0314	54
15	28/15	40.0315	54

COVERS CSD SERIES 28.4

**28 SERIES**  
ID CONDUIT OPENING 27.5-28.5 MM

cable/ pipe diameter	plug type	article number	plug length
blind	30/0	40.0400	54
5-6	30/5-6	40.0405	54
6-7	30/6-7	40.0406	54
7-8	30/7-8	40.0407	54
8-9	30/8-9	40.0408	54
9-10	30/9-10	40.0409	54
10-11	30/10-11	40.0410	54
11-12	30/11-12	40.0411	54
12-13	30/12-13	40.0412	54
13-14	30/13-14	40.0413	54
14-15	30/14-15	40.0414	54
15-16	30/15-16	40.0415	54
16	30/16	40.0416	54

COVERS CSD SERIES 30

**30 SERIES**  
ID CONDUIT OPENING 29.5-30.5 MM

# SLIPSIL® SEALING PLUGS: HIGH-TECH NOFIRNO® TECHNOLOGY

## TABLES FOR SINGLE SEALING PLUGS

cable/ pipe diameter	plug type	article number	plug length
blind	32/0	40.0500	54
5-6	32/5-6	40.0505	54
6-7	32/6-7	40.0506	54
7-8	32/7-8	40.0507	54
8-9	32/8-9	40.0508	54
9-10	32/9-10	40.0509	54
10-11	32/10-11	40.0510	54
11-12	32/11-12	40.0511	54
12-13	32/12-13	40.0512	54
13-14	32/13-14	40.0513	54
14-15	32/14-15	40.0514	54
15-16	32/15-16	40.0515	54
16	32/16	40.0516	54

*COVERS CSD SERIES 32*

## 32 SERIES

ID CONDUIT OPENING 31.5-32.5 MM

cable/ pipe diameter	plug type	article number	plug length
blind	34/0	40.0600	54
5-6	34/5-6	40.0605	54
6-7	34/6-7	40.0606	54
7-8	34/7-8	40.0607	54
8-9	34/8-9	40.0608	54
9-10	34/9-10	40.0609	54
10-11	34/10-11	40.0610	54
11-12	34/11-12	40.0611	54
12-13	34/12-13	40.0612	54
13-14	34/13-14	40.0613	54
14-15	34/14-15	40.0614	54
15-16	34/15-16	40.0615	54
16-17	34/16-17	40.0616	54
17-18	34/17-18	40.0617	54
18	34/18	40.0618	54

*COVERS CSD SERIES 33.6*

## 34 SERIES

ID CONDUIT OPENING 33.5-34.5 MM

cable/ pipe diameter	plug type	article number	plug length
blind	35/0	40.0700	54
5-6	35/5-6	40.0705	54
6-7	35/6-7	40.0706	54
7-8	35/7-8	40.0707	54
8-9	35/8-9	40.0708	54
9-10	35/9-10	40.0709	54
10-11	35/10-11	40.0710	54
11-12	35/11-12	40.0711	54
12-13	35/12-13	40.0712	54
13-14	35/13-14	40.0713	54
14-15	35/14-15	40.0714	54
15-16	35/15-16	40.0715	54
16-17	35/16-17	40.0716	54
17-18	35/17-18	40.0717	54
18-19	35/18-19	40.0718	54
19-20	35/19-20	40.0719	54
20	35/20	40.0720	54

*COVERS CSD SERIES 35, 35.7*

## 35 SERIES

ID CONDUIT OPENING 34.5-35.7 MM

cable/ pipe diameter	plug type	article number	plug length
blind	37/0	40.0800	54
5-6	37/5-6	40.0805	54
6-7	37/6-7	40.0806	54
7-8	37/7-8	40.0807	54
8-9	37/8-9	40.0808	54
9-10	37/9-10	40.0809	54
10-11	37/10-11	40.0810	54
11-12	37/11-12	40.0811	54
12-13	37/12-13	40.0812	54
13-14	37/13-14	40.0813	54
14-15	37/14-15	40.0814	54
15-16	37/15-16	40.0815	54
16-17	37/16-17	40.0816	54
17-18	37/17-18	40.0817	54
18-19	37/18-19	40.0818	54
19-20	37/19-20	40.0819	54
20	37/20	40.0820	54

*COVERS CSD SERIES 36.5, 37.2*

## 37 SERIES

ID CONDUIT OPENING 36.5-37.7 MM



# SLIPSIL® SEALING PLUGS: HIGH-TECH NOFIRNO® TECHNOLOGY

## TABLES FOR SINGLE SEALING PLUGS

cable/ pipe diameter	plug type	article number	plug length
blind	40/0	40.0900	54
5-6	40/5-6	40.0905	54
6-7	40/6-7	40.0906	54
7-8	40/7-8	40.0907	54
8-9	40/8-9	40.0908	54
9-10	40/9-10	40.0909	54
10-11	40/10-11	40.0910	54
11-12	40/11-12	40.0911	54
12-14	40/12-14	40.0912	54
14-16	40/14-16	40.0913	54
16-18	40/16-18	40.0914	54
18-20	40/18-20	40.0915	54
20-21	40/20-21	40.0916	54
21-22	40/21-22	40.0917	54
22	40/22	40.0918	54

COVERS CSD SERIES 40

### 40 SERIES

ID CONDUIT OPENING 39.5-40.7 MM

cable/ pipe diameter	plug type	article number	plug length
blind	41/0	40.1000	54
5-6	41/5-6	40.1005	54
6-7	41/6-7	40.1006	54
7-8	41/7-8	40.1007	54
8-9	41/8-9	40.1008	54
9-10	41/9-10	40.1009	54
10-11	41/10-11	40.1010	54
11-12	41/11-12	40.1011	54
12-14	41/12-14	40.1012	54
14-16	41/14-16	40.1013	54
16-18	41/16-18	40.1014	54
18-20	41/18-20	40.1015	54
20-22	41/20-22	40.1016	54
22-23	41/22-23	40.1017	54
23-24	41/23-24	40.1018	54
24-25	41/24-25	40.1019	54
25	41/25	40.1020	54

COVERS CSD SERIES 41.1, 41.6

### 41 SERIES

ID CONDUIT OPENING 40.5-41.7 MM

cable/ pipe diameter	plug type	article number	plug length
blind	43/0	40.1100	54
5-6	43/5-6	40.1105	54
6-7	43/6-7	40.1106	54
7-8	43/7-8	40.1107	54
8-9	43/8-9	40.1108	54
9-10	43/9-10	40.1109	54
10-12	43/10-12	40.1110	54
12-14	43/12-14	40.1111	54
14-16	43/14-16	40.1112	54
16-18	43/16-18	40.1113	54
18-20	43/18-20	40.1114	54
20-22	43/20-22	40.1115	54
22-24	43/22-24	40.1116	54
24-25	43/24-25	40.1117	54
25-26	43/25-26	40.1118	54
26-27	43/26-27	40.1119	54
27-28	43/27-28	40.1120	54
28	43/28	40.1121	54

COVERS CSD SERIES 43.6

### 43 SERIES

ID CONDUIT OPENING 42.5-43.7 MM

cable/ pipe diameter	plug type	article number	plug length
blind	50/0	40.1200	66
10-12	50/10-12	40.1209	66
12-14	50/12-14	40.1210	66
14-16	50/14-16	40.1211	66
16-18	50/16-18	40.1212	66
18-20	50/18-20	40.1213	66
20-22	50/20-22	40.1214	66
22-24	50/22-24	40.1215	66
24-26	50/24-26	40.1216	66
26-28	50/26-28	40.1217	66
28-29	50/28-29	40.1218	66
29-30	50/29-30	40.1219	66
30-31	50/30-31	40.1220	66
31-32	50/31-32	40.1221	66
32	50/32	40.1222	66

COVERS CSD SERIES 50

### 50 SERIES

ID CONDUIT OPENING 49.5-50.7 MM

# SLIPSIL® SEALING PLUGS: HIGH-TECH NOFIRNO® TECHNOLOGY

## TABLES FOR SINGLE SEALING PLUGS

cable/ pipe diameter	plug type	article number	plug length
blind	53/0	40.1300	66
10-12	53/10-12	40.1309	66
12-14	53/12-14	40.1310	66
14-16	53/14-16	40.1311	66
16-18	53/16-18	40.1312	66
18-20	53/18-20	40.1313	66
20-22	53/20-22	40.1314	66
22-24	53/22-24	40.1315	66
24-26	53/24-26	40.1316	66
26-28	53/26-28	40.1317	66
28-30	53/28-30	40.1318	66
30-31	53/30-31	40.1319	66
31-32	53/31-32	40.1320	66
32-33	53/32-33	40.1321	66
33-34	53/33-34	40.1322	66
34	53/34	40.1323	66

COVERS CSD SERIES 52.5, 52.9, 53.7

**53 SERIES**  
ID CONDUIT OPENING 52-53.7 MM

cable/ pipe diameter	plug type	article number	plug length
blind	55/0	40.1400	66
10-12	55/10-12	40.1409	66
12-14	55/12-14	40.1410	66
14-16	55/14-16	40.1411	66
16-18	55/16-18	40.1412	66
18-20	55/18-20	40.1413	66
20-22	55/20-22	40.1414	66
22-24	55/22-24	40.1415	66
24-26	55/24-26	40.1416	66
26-28	55/26-28	40.1417	66
28-30	55/28-30	40.1418	66
30-31	55/30-31	40.1419	66
31-32	55/31-32	40.1420	66
32-33	55/32-33	40.1421	66
33-34	55/33-34	40.1422	66
34	55/34	40.1423	66

COVERS CSD SERIES 54.5

**55 SERIES**  
ID CONDUIT OPENING 54-55.7 MM

cable/ pipe diameter	plug type	article number	plug length
blind	57/0	40.1500	66
14-16	57/14-16	40.1511	66
16-18	57/16-18	40.1512	66
18-20	57/18-20	40.1513	66
20-22	57/20-22	40.1514	66
22-24	57/22-24	40.1515	66
24-26	57/24-26	40.1516	66
26-28	57/26-28	40.1517	66
28-30	57/28-30	40.1518	66
30-32	57/30-32	40.1519	66
32-34	57/32-34	40.1520	66
34-36	57/34-36	40.1521	66
36-37	57/36-37	40.1522	66
37-38	57/37-38	40.1523	66
38-39	57/38-39	40.1524	66
39-40	57/39-40	40.1525	66
40	57/40	40.1526	66

COVERS CSD SERIES 57

**57 SERIES**  
ID CONDUIT OPENING 56-57.7 MM

cable/ pipe diameter	plug type	article number	plug length
blind	60/0	40.1600	66
14-16	60/14-16	40.1611	66
16-18	60/16-18	40.1612	66
18-20	60/18-20	40.1613	66
20-22	60/20-22	40.1614	66
22-24	60/22-24	40.1615	66
24-26	60/24-26	40.1616	66
26-28	60/26-28	40.1617	66
28-30	60/28-30	40.1618	66
30-32	60/30-32	40.1619	66
32-34	60/32-34	40.1620	66
34-36	60/34-36	40.1621	66
36-37	60/36-37	40.1622	66
37-38	60/37-38	40.1623	66
38-39	60/38-39	40.1624	66
39-40	60/39-40	40.1625	66
40	60/40	40.1626	66

COVERS CSD SERIES 60

**60 SERIES**  
ID CONDUIT OPENING 59-60.7 MM

# SLIPSIL® SEALING PLUGS: HIGH-TECH NOFIRNO® TECHNOLOGY

## TABLES FOR SINGLE SEALING PLUGS

cable/ pipe diameter	plug type	article number	plug length
blind	62/0	40.1700	66
14-16	62/14-16	40.1711	66
16-18	62/16-18	40.1712	66
18-20	62/18-20	40.1713	66
20-22	62/20-22	40.1714	66
22-24	62/22-24	40.1715	66
24-26	62/24-26	40.1716	66
26-28	62/26-28	40.1717	66
28-30	62/28-30	40.1718	66
30-32	62/30-32	40.1719	66
32-34	62/32-34	40.1720	66
34-36	62/34-36	40.1721	66
36-37	62/36-37	40.1722	66
37-38	62/37-38	40.1723	66
38-39	62/38-39	40.1724	66
39-40	62/39-40	40.1725	66
40	62/40	40.1726	66

COVERS CSD SERIES 62.3

**62 SERIES**  
ID CONDUIT OPENING 61-62.7 MM

cable/ pipe diameter	plug type	article number	plug length
blind	67/0	40.1800	66
22-24	67/22-24	40.1815	66
24-26	67/24-26	40.1816	66
26-28	67/26-28	40.1817	66
28-30	67/28-30	40.1818	66
30-32	67/30-32	40.1819	66
32-34	67/32-34	40.1820	66
34-36	67/34-36	40.1821	66
36-38	67/36-38	40.1822	66
38-40	67/38-40	40.1823	66
40-42	67/40-42	40.1824	66
42-44	67/42-44	40.1825	66
44-46	67/44-46	40.1826	66
46-48	67/46-48	40.1827	66
48-50	67/48-50	40.1828	66
50	67/50	40.1829	66

COVERS CSD SERIES 67.1

**67 SERIES**  
ID CONDUIT OPENING 66-67.7 MM

cable/ pipe diameter	plug type	article number	plug length
blind	68/0	40.1900	66
22-24	68/22-24	40.1915	66
24-26	68/24-26	40.1916	66
26-28	68/26-28	40.1917	66
28-30	68/28-30	40.1918	66
30-32	68/30-32	40.1919	66
32-34	68/32-34	40.1920	66
34-36	68/34-36	40.1921	66
36-38	68/36-38	40.1922	66
38-40	68/38-40	40.1923	66
40-42	68/40-42	40.1924	66
42-44	68/42-44	40.1925	66
44-46	68/44-46	40.1926	66
46-48	68/46-48	40.1927	66
48-50	68/48-50	40.1928	66
50	68/50	40.1929	66

COVERS CSD SERIES 67.9, 68.6

**68 SERIES**  
ID CONDUIT OPENING 67-68.7 MM

cable/ pipe diameter	plug type	article number	plug length
blind	70/0	40.2000	66
22-24	70/22-24	40.2015	66
24-26	70/24-26	40.2016	66
26-28	70/26-28	40.2017	66
28-30	70/28-30	40.2018	66
30-32	70/30-32	40.2019	66
32-34	70/32-34	40.2020	66
34-36	70/34-36	40.2021	66
36-38	70/36-38	40.2022	66
38-40	70/38-40	40.2023	66
40-42	70/40-42	40.2024	66
42-44	70/42-44	40.2025	66
44-46	70/44-46	40.2026	66
46-48	70/46-48	40.2027	66
48-50	70/48-50	40.2028	66
50	70/50	40.2029	66

COVERS CSD SERIES 70

**70 SERIES**  
ID CONDUIT OPENING 69-70.7 MM

# SLIPSIL® SEALING PLUGS: HIGH-TECH NOFIRNO® TECHNOLOGY

## TABLES FOR SINGLE SEALING PLUGS

cable/ pipe diameter	plug type	article number	plug length
blind	75/0	40.2100	66
22-24	75/22-24	40.2115	66
24-26	75/24-26	40.2116	66
26-28	75/26-28	40.2117	66
28-30	75/28-30	40.2118	66
30-32	75/30-32	40.2119	66
32-34	75/32-34	40.2120	66
34-36	75/34-36	40.2121	66
36-38	75/36-38	40.2122	66
38-40	75/38-40	40.2123	66
40-42	75/40-42	40.2124	66
42-44	75/42-44	40.2125	66
44-46	75/44-46	40.2126	66
46-48	75/46-48	40.2127	66
48-50	75/48-50	40.2128	66
50	75/50	40.2129	66

COVERS CSD SERIES 75

**75 SERIES**  
ID CONDUIT OPENING 74-75.7 MM

cable/ pipe diameter	plug type	article number	plug length
blind	78/0	40.2200	66
22-24	78/22-24	40.2215	66
24-26	78/24-26	40.2216	66
26-28	78/26-28	40.2217	66
28-30	78/28-30	40.2218	66
30-32	78/30-32	40.2219	66
32-34	78/32-34	40.2220	66
34-36	78/34-36	40.2221	66
36-38	78/36-38	40.2222	66
38-40	78/38-40	40.2223	66
40-42	78/40-42	40.2224	66
42-44	78/42-44	40.2225	66
44-46	78/44-46	40.2226	66
46-48	78/46-48	40.2227	66
48-50	78/48-50	40.2228	66
50-52	78/50-52	40.2229	66
52-53	78/52-53	40.2230	66
53-54	78/53-54	40.2231	66
54	78/54	40.2232	66

COVERS CSD SERIES 77.9

**78 SERIES**  
ID CONDUIT OPENING 77-78.7 MM

cable/ pipe diameter	plug type	article number	plug length
blind	80/0	40.2300	66
28-30	80/28-30	40.2318	66
30-32	80/30-32	40.2319	66
32-34	80/32-34	40.2320	66
34-36	80/34-36	40.2321	66
36-38	80/36-38	40.2322	66
38-40	80/38-40	40.2323	66
40-42	80/40-42	40.2324	66
42-44	80/42-44	40.2325	66
44-46	80/44-46	40.2326	66
46-48	80/46-48	40.2327	66
48-50	80/48-50	40.2328	66
50-52	80/50-52	40.2329	66
52-54	80/52-54	40.2330	66
54-56	80/54-56	40.2331	66
56-58	80/56-58	40.2332	66
58-60	80/58-60	40.2333	66
60	80/60	40.2334	66

COVERS CSD SERIES 80, 80.7

**80 SERIES**  
ID CONDUIT OPENING 79-80.7 MM

cable/ pipe diameter	plug type	article number	plug length
blind	82/0	40.2400	66
28-30	82/28-30	40.2418	66
30-32	82/30-32	40.2419	66
32-34	82/32-34	40.2420	66
34-36	82/34-36	40.2421	66
36-38	82/36-38	40.2422	66
38-40	82/38-40	40.2423	66
40-42	82/40-42	40.2424	66
42-44	82/42-44	40.2425	66
44-46	82/44-46	40.2426	66
46-48	82/46-48	40.2427	66
48-50	82/48-50	40.2428	66
50-52	82/50-52	40.2429	66
52-54	82/52-54	40.2430	66
54-56	82/54-56	40.2431	66
56-58	82/56-58	40.2432	66
58-60	82/58-60	40.2433	66
60	82/60	40.2434	66

COVERS CSD SERIES 81.7, 82.5

**82 SERIES**  
ID CONDUIT OPENING 81-82.7 MM

# SLIPSIL® SEALING PLUGS: HIGH-TECH NOFIRNO® TECHNOLOGY

## TABLES FOR SINGLE SEALING PLUGS

cable/ pipe diameter	plug type	article number	plug length
blind	90/0	40.2500	66
40-42	90/40-42	40.2520	66
42-44	90/42-44	40.2521	66
44-46	90/44-46	40.2522	66
46-48	90/46-48	40.2523	66
48-50	90/48-50	40.2524	66
50-52	90/50-52	40.2525	66
52-54	90/52-54	40.2526	66
54-56	90/54-56	40.2527	66
56-58	90/56-58	40.2528	66
58-60	90/58-60	40.2529	66
60-62	90/60-62	40.2530	66
62-64	90/62-64	40.2531	66
64	90/64	40.2532	66

*COVERS CSD SERIES 90*

## 90 SERIES

ID CONDUIT OPENING 89-90.7 MM

cable/ pipe diameter	plug type	article number	plug length
blind	94/0	40.2600	66
40-42	94/40-42	40.2620	66
42-44	94/42-44	40.2621	66
44-46	94/44-46	40.2622	66
46-48	94/46-48	40.2623	66
48-50	94/48-50	40.2624	66
50-52	94/50-52	40.2625	66
52-54	94/52-54	40.2626	66
54-56	94/54-56	40.2627	66
56-58	94/56-58	40.2628	66
58-60	94/58-60	40.2629	66
60-62	94/60-62	40.2630	66
62-64	94/62-64	40.2631	66
64	94/64	40.2632	66

*COVERS CSD SERIES 94*

## 94 SERIES

ID CONDUIT OPENING 93-94.7 MM

cable/ pipe diameter	plug type	article number	plug length
blind	97/0	40.2700	66
40-42	97/40-42	40.2720	66
42-44	97/42-44	40.2721	66
44-46	97/44-46	40.2722	66
46-48	97/46-48	40.2723	66
48-50	97/48-50	40.2724	66
50-52	97/50-52	40.2725	66
52-54	97/52-54	40.2726	66
54-56	97/54-56	40.2727	66
56-58	97/56-58	40.2728	66
58-60	97/58-60	40.2729	66
60-62	97/60-62	40.2730	66
62-64	97/62-64	40.2731	66
64	97/64	40.2732	66

*COVERS CSD SERIES 97.2*

## 97 SERIES

ID CONDUIT OPENING 96-97.7 MM

cable/ pipe diameter	plug type	article number	plug length
blind	100/0	40.2800	66
40-42	100/40-42	40.2820	66
42-44	100/42-44	40.2821	66
44-46	100/44-46	40.2822	66
46-48	100/46-48	40.2823	66
48-50	100/48-50	40.2824	66
50-52	100/50-52	40.2825	66
52-54	100/52-54	40.2826	66
54-56	100/54-56	40.2827	66
56-58	100/56-58	40.2828	66
58-60	100/58-60	40.2829	66
60-62	100/60-62	40.2830	66
62-64	100/62-64	40.2831	66
64-66	100/64-66	40.2832	66
66-68	100/66-68	40.2833	66
68-70	100/68-70	40.2834	66
70-72	100/70-72	40.2835	66
72-74	100/72-74	40.2836	66
74-75	100/74-75	40.2837	66
75	100/75	40.2838	66

*COVERS CSD SERIES 100*

## 100 SERIES

ID CONDUIT OPENING 99-100.7 MM

# SLIPSIL® SEALING PLUGS: HIGH-TECH NOFIRNO® TECHNOLOGY

## TABLES FOR SINGLE SEALING PLUGS

cable/ pipe diameter	plug type	article number	plug length
blind	102/0	40.2900	66
40-42	102/40-42	40.2920	66
42-44	102/42-44	40.2921	66
44-46	102/44-46	40.2922	66
46-48	102/46-48	40.2923	66
48-50	102/48-50	40.2924	66
50-52	102/50-52	40.2925	66
52-54	102/52-54	40.2926	66
54-56	102/54-56	40.2927	66
56-58	102/56-58	40.2928	66
58-60	102/58-60	40.2929	66
60-62	102/60-62	40.2930	66
62-64	102/62-64	40.2931	66
64-66	102/64-66	40.2932	66
66-68	102/66-68	40.2933	66
68-70	102/68-70	40.2934	66
70-72	102/70-72	40.2935	66
72-74	102/72-74	40.2936	66
74-75	102/74-75	40.2937	66
75	102/75	40.2938	66

### 102 SERIES

ID CONDUIT OPENING 101-102.7 MM

cable/ pipe diameter	plug type	article number	plug length
blind	103/0	40.3000	66
40-42	103/40-42	40.3020	66
42-44	103/42-44	40.3021	66
44-46	103/44-46	40.3022	66
46-48	103/46-48	40.3023	66
48-50	103/48-50	40.3024	66
50-52	103/50-52	40.3025	66
52-54	103/52-54	40.3026	66
54-56	103/54-56	40.3027	66
56-58	103/56-58	40.3028	66
58-60	103/58-60	40.3029	66
60-62	103/60-62	40.3030	66
62-64	103/62-64	40.3031	66
64-66	103/64-66	40.3032	66
66-68	103/66-68	40.3033	66
68-70	103/68-70	40.3034	66
70-72	103/70-72	40.3035	66
72-74	103/72-74	40.3036	66
74-75	103/74-75	40.3037	66
75	103/75	40.3038	66

### 103 SERIES

ID CONDUIT OPENING 102-103.7 MM

cable/ pipe diameter	plug type	article number	plug length
blind	105/0	40.3100	66
40-42	105/40-42	40.3120	66
42-44	105/42-44	40.3121	66
44-46	105/44-46	40.3122	66
46-48	105/46-48	40.3123	66
48-50	105/48-50	40.3124	66
50-52	105/50-52	40.3125	66
52-54	105/52-54	40.3126	66
54-56	105/54-56	40.3127	66
56-58	105/56-58	40.3128	66
58-60	105/58-60	40.3129	66
60-62	105/60-62	40.3130	66
62-64	105/62-64	40.3131	66
64-66	105/64-66	40.3132	66
66-68	105/66-68	40.3133	66
68-70	105/68-70	40.3134	66
70-72	105/70-72	40.3135	66
72-74	105/72-74	40.3136	66
74-75	105/74-75	40.3137	66
75	105/75	40.3138	66

### 105 SERIES

ID CONDUIT OPENING 104-105.7 MM

cable/ pipe diameter	plug type	article number	plug length
blind	107/0	40.3200	66
40-42	107/40-42	40.3220	66
42-44	107/42-44	40.3221	66
44-46	107/44-46	40.3222	66
46-48	107/46-48	40.3223	66
48-50	107/48-50	40.3224	66
50-52	107/50-52	40.3225	66
52-54	107/52-54	40.3226	66
54-56	107/54-56	40.3227	66
56-58	107/56-58	40.3228	66
58-60	107/58-60	40.3229	66
60-62	107/60-62	40.3230	66
62-64	107/62-64	40.3231	66
64-66	107/64-66	40.3232	66
66-68	107/66-68	40.3233	66
68-70	107/68-70	40.3234	66
70-72	107/70-72	40.3235	66
72-74	107/72-74	40.3236	66
74-75	107/74-75	40.3237	66
75	107/75	40.3238	66

### 107 SERIES

ID CONDUIT OPENING 106-107.7 MM

# SLIPSIL® SEALING PLUGS: HIGH-TECH NOFIRNO® TECHNOLOGY

## TABLES FOR SINGLE SEALING PLUGS

cable/ pipe diameter	plug type	article number	plug length
blind	110/0	40.3300	66
48-50	110/48-50	40.3324	66
50-52	110/50-52	40.3325	66
52-54	110/52-54	40.3326	66
54-56	110/54-56	40.3327	66
56-58	110/56-58	40.3328	66
58-60	110/58-60	40.3329	66
60-62	110/60-62	40.3330	66
62-64	110/62-64	40.3331	66
64-66	110/64-66	40.3332	66
66-68	110/66-68	40.3333	66
68-70	110/68-70	40.3334	66
70-72	110/70-72	40.3335	66
72-74	110/72-74	40.3336	66
74-76	110/74-76	40.3337	66
76-78	110/76-78	40.3338	66
78-80	110/78-80	40.3339	66
80	110/80	40.3340	66

### 110 SERIES

ID CONDUIT OPENING 109-110.7 MM

cable/ pipe diameter	plug type	article number	plug length
blind	118/0	40.3400	66
60-62	118/60-62	40.3430	66
62-64	118/62-64	40.3431	66
64-66	118/64-66	40.3432	66
66-68	118/66-68	40.3433	66
68-70	118/68-70	40.3434	66
70-72	118/70-72	40.3435	66
72-74	118/72-74	40.3436	66
74-76	118/74-76	40.3437	66
76-78	118/76-78	40.3438	66
78-80	118/78-80	40.3439	66
80-82	118/80-82	40.3440	66
82-84	118/82-84	40.3441	66
84-86	118/84-86	40.3442	66
86-88	118/86-88	40.3443	66
88-90	118/88-90	40.3444	66
90	118/90	40.3445	66

COVERS CSD SERIES 118.6

### 118 SERIES

ID CONDUIT OPENING 117.5-119.2 MM

cable/ pipe diameter	plug type	article number	plug length
blind	122/0	40.3500	66
60-62	122/60-62	40.3530	66
62-64	122/62-64	40.3531	66
64-66	122/64-66	40.3532	66
66-68	122/66-68	40.3533	66
68-70	122/68-70	40.3534	66
70-72	122/70-72	40.3535	66
72-74	122/72-74	40.3536	66
74-76	122/74-76	40.3537	66
76-78	122/76-78	40.3538	66
78-80	122/78-80	40.3539	66
80-82	122/80-82	40.3540	66
82-84	122/82-84	40.3541	66
84-86	122/84-86	40.3542	66
86-88	122/86-88	40.3543	66
88-90	122/88-90	40.3544	66
90-92	122/90-92	40.3545	66
92	122/92	40.3546	66

COVERS CSD SERIES 122.2

### 122 SERIES

ID CONDUIT OPENING 121-122.7 MM

cable/ pipe diameter	plug type	article number	plug length
blind	125/0	40.3600	66
60-62	125/60-62	40.3630	66
62-64	125/62-64	40.3631	66
64-66	125/64-66	40.3632	66
66-68	125/66-68	40.3633	66
68-70	125/68-70	40.3634	66
70-72	125/70-72	40.3635	66
72-74	125/72-74	40.3636	66
74-76	125/74-76	40.3637	66
76-78	125/76-78	40.3638	66
78-80	125/78-80	40.3639	66
80-82	125/80-82	40.3640	66
82-84	125/82-84	40.3641	66
84-86	125/84-86	40.3642	66
86-88	125/86-88	40.3643	66
88-90	125/88-90	40.3644	66
90-92	125/90-92	40.3645	66
92	125/92	40.3646	66

COVERS CSD SERIES 125

### 125 SERIES

ID CONDUIT OPENING 124-125.7 MM

# SLIPSIL® SEALING PLUGS: HIGH-TECH NOFIRNO® TECHNOLOGY

## TABLES FOR SINGLE SEALING PLUGS

cable/ pipe diameter	plug type	article number	plug length
blind	128/0	40.3700	66
60-62	128/60-62	40.3730	66
62-64	128/62-64	40.3731	66
64-66	128/64-66	40.3732	66
66-68	128/66-68	40.3733	66
68-70	128/68-70	40.3734	66
70-72	128/70-72	40.3735	66
72-74	128/72-74	40.3736	66
74-76	128/74-76	40.3737	66
76-78	128/76-78	40.3738	66
78-80	128/78-80	40.3739	66
80-82	128/80-82	40.3740	66
82-84	128/82-84	40.3741	66
84-86	128/84-86	40.3742	66
86-88	128/86-88	40.3743	66
88-90	128/88-90	40.3744	66
90-92	128/90-92	40.3745	66
92	128/92	40.3746	66

COVERS CSD SERIES 128.1

## 128 SERIES

ID CONDUIT OPENING 127-128.7 MM

cable/ pipe diameter	plug type	article number	plug length
blind	131/0	40.3800	66
60-62	131/60-62	40.3830	66
62-64	131/62-64	40.3831	66
64-66	131/64-66	40.3832	66
66-68	131/66-68	40.3833	66
68-70	131/68-70	40.3834	66
70-72	131/70-72	40.3835	66
72-74	131/72-74	40.3836	66
74-76	131/74-76	40.3837	66
76-78	131/76-78	40.3838	66
78-80	131/78-80	40.3839	66
80-82	131/80-82	40.3840	66
82-84	131/82-84	40.3841	66
84-86	131/84-86	40.3842	66
86-88	131/86-88	40.3843	66
88-90	131/88-90	40.3844	66
90-92	131/90-92	40.3845	66
92	131/92	40.3846	66

COVERS CSD SERIES 131.7

## 131 SERIES

ID CONDUIT OPENING 130.5-132.2 MM

cable/ pipe diameter	plug type	article number	plug length
blind	146/0	40.3900	79
88-90	146/88-90	40.3920	79
90-92	146/90-92	40.3921	79
92-94	146/92-94	40.3922	79
94-96	146/94-96	40.3923	79
96-98	146/96-98	40.3924	79
98-100	146/98-100	40.3925	79
100-102	146/100-102	40.3926	79
102-104	146/102-104	40.3927	79
104-106	146/104-106	40.3928	79
106-108	146/106-108	40.3929	79
108-110	146/108-110	40.3930	79
110-112	146/110-112	40.3931	79
112-114	146/112-114	40.3932	79
114-116	146/114-116	40.3933	79
116-118	146/116-118	40.3934	79
118-120	146/118-120	40.3935	79
120	146/120	40.3936	79

COVERS CSD SERIES 146.3

## 146 SERIES

ID CONDUIT OPENING 145-146.7 MM

cable/ pipe diameter	plug type	article number	plug length
blind	150/0	40.4000	79
88-90	150/88-90	40.4020	79
90-92	150/90-92	40.4021	79
92-94	150/92-94	40.4022	79
94-96	150/94-96	40.4023	79
96-98	150/96-98	40.4024	79
98-100	150/98-100	40.4025	79
100-102	150/100-102	40.4026	79
102-104	150/102-104	40.4027	79
104-106	150/104-106	40.4028	79
106-108	150/106-108	40.4029	79
108-110	150/108-110	40.4030	79
110-112	150/110-112	40.4031	79
112-114	150/112-114	40.4032	79
114-116	150/114-116	40.4033	79
116-118	150/116-118	40.4034	79
118-120	150/118-120	40.4035	79
120-122	150/120-122	40.4036	79
122-124	150/122-124	40.4037	79
124-125	150/124-125	40.4038	79
125	150/125	40.4039	79

## 150 SERIES

ID CONDUIT OPENING 149-150.7 MM



# SLIPSIL® SEALING PLUGS: HIGH-TECH NOFIRNO® TECHNOLOGY

## TABLES FOR SINGLE SEALING PLUGS

cable/ pipe diameter	plug type	article number	plug length
blind	152/0	40.4100	79
88-90	152/88-90	40.4120	79
90-92	152/90-92	40.4121	79
92-94	152/92-94	40.4122	79
94-96	152/94-96	40.4123	79
96-98	152/96-98	40.4124	79
98-100	152/98-100	40.4125	79
100-102	152/100-102	40.4126	79
102-104	152/102-104	40.4127	79
104-106	152/104-106	40.4128	79
106-108	152/106-108	40.4129	79
108-110	152/108-110	40.4130	79
110-112	152/110-112	40.4131	79
112-114	152/112-114	40.4132	79
114-116	152/114-116	40.4133	79
116-118	152/116-118	40.4134	79
118-120	152/118-120	40.4135	79
120-122	152/120-122	40.4136	79
122-124	152/122-124	40.4137	79
124-125	152/124-125	40.4138	79
125	152/125	40.4139	79

### 152 SERIES

ID CONDUIT OPENING 151-152.7 MM

cable/ pipe diameter	plug type	article number	plug length
blind	154/0	40.4200	79
88-90	154/88-90	40.4220	79
90-92	154/90-92	40.4221	79
92-94	154/92-94	40.4222	79
94-96	154/94-96	40.4223	79
96-98	154/96-98	40.4224	79
98-100	154/98-100	40.4225	79
100-102	154/100-102	40.4226	79
102-104	154/102-104	40.4227	79
104-106	154/104-106	40.4228	79
106-108	154/106-108	40.4229	79
108-110	154/108-110	40.4230	79
110-112	154/110-112	40.4231	79
112-114	154/112-114	40.4232	79
114-116	154/114-116	40.4233	79
116-118	154/116-118	40.4234	79
118-120	154/118-120	40.4235	79
120-122	154/120-122	40.4236	79
122-124	154/122-124	40.4237	79
124-125	154/124-125	40.4238	79
125	154/125	40.4239	79

### 154 SERIES

ID CONDUIT OPENING 153-154.7 MM

cable/ pipe diameter	plug type	article number	plug length
blind	156/0	40.4300	79
88-90	156/88-90	40.4320	79
90-92	156/90-92	40.4321	79
92-94	156/92-94	40.4322	79
94-96	156/94-96	40.4323	79
96-98	156/96-98	40.4324	79
98-100	156/98-100	40.4325	79
100-102	156/100-102	40.4326	79
102-104	156/102-104	40.4327	79
104-106	156/104-106	40.4328	79
106-108	156/106-108	40.4329	79
108-110	156/108-110	40.4330	79
110-112	156/110-112	40.4331	79
112-114	156/112-114	40.4332	79
114-116	156/114-116	40.4333	79
116-118	156/116-118	40.4334	79
118-120	156/118-120	40.4335	79
120-122	156/120-122	40.4336	79
122-124	156/122-124	40.4337	79
124-125	156/124-125	40.4338	79
125	156/125	40.4339	79

### 156 SERIES

ID CONDUIT OPENING 155-156.7 MM

cable/ pipe diameter	plug type	article number	plug length
blind	160/0	40.4400	79
88-90	160/88-90	40.4420	79
90-92	160/90-92	40.4421	79
92-94	160/92-94	40.4422	79
94-96	160/94-96	40.4423	79
96-98	160/96-98	40.4424	79
98-100	160/98-100	40.4425	79
100-102	160/100-102	40.4426	79
102-104	160/102-104	40.4427	79
104-106	160/104-106	40.4428	79
106-108	160/106-108	40.4429	79
108-110	160/108-110	40.4430	79
110-112	160/110-112	40.4431	79
112-114	160/112-114	40.4432	79
114-116	160/114-116	40.4433	79
116-118	160/116-118	40.4434	79
118-120	160/118-120	40.4435	79
120-122	160/120-122	40.4436	79
122-124	160/122-124	40.4437	79
124-125	160/124-125	40.4438	79
125	160/125	40.4439	79

### 160 SERIES

ID CONDUIT OPENING 159-160.7 MM

# SLIPSIL® SEALING PLUGS: HIGH-TECH NOFIRNO® TECHNOLOGY

## TABLES FOR SINGLE SEALING PLUGS

cable/ pipe diameter	plug type	article number	plug length
blind	190/0	40.4500	79
110-112	190/110	40.4520	79
114-116	190/114	40.4523	79
125-127	190/125	40.4528	79
133-135	190/133	40.4531	79
139-141	190/139	40.4533	79
142-144	190/142	40.4534	79
153-155	190/153	40.4541	79
159-161	190/159	40.4543	79

COVERS CSD SERIES 190.2

**190 SERIES**  
ID CONDUIT OPENING 189-190.7 MM

cable/ pipe diameter	plug type	article number	plug length
blind	200/0	40.4600	79
110-112	200/110	40.4620	79
114-116	200/114	40.4623	79
120-122	200/120	40.4626	79
125-127	200/125	40.4628	79
133-135	200/133	40.4631	79
139-141	200/139	40.4633	79
159-161	200/159	40.4643	79

COVERS CSD SERIES 200

**200 SERIES**  
ID CONDUIT OPENING 199-200.7 MM

cable/ pipe diameter	plug type	article number	plug length
blind	203/0	40.4700	79
110-112	203/110	40.4720	79
114-116	203/114	40.4723	79
125-127	203/125	40.4728	79
133-135	203/133	40.4731	79
139-141	203/139	40.4733	79
141-143	203/141	40.4734	79
159-161	203/159	40.4743	79
168-170	203/168	40.4748	79

COVERS CSD SERIES 202.7

**203 SERIES**  
ID CONDUIT OPENING 202-203.7 MM

cable/ pipe diameter	plug type	article number	plug length
blind	207/0	40.4800	79
110-112	207/110	40.4820	79
114-116	207/114	40.4823	79
125-127	207/125	40.4828	79
133-135	207/133	40.4831	79
139-141	207/139	40.4833	79
159-161	207/159	40.4843	79
168-170	207/168	40.4848	79

COVERS CSD SERIES 207.3

**207 SERIES**  
ID CONDUIT OPENING 206-207.7 MM

# SLIPSIL® SEALING PLUGS: HIGH-TECH NOFIRNO® TECHNOLOGY

*SLIPSIL® multi-sealing plugs consist of two or four equal parts, so that they can be installed after the cables or pipes have been laid. The multi-plugs are specially developed for hydraulic and pneumatic systems in which same diameter pipes are used. Application of SLIPSIL® multi-sealing plugs avoids the need of spreading the pipes out to make single penetrations for each of the pipes. This saves a lot of space and also a lot of extra workmanship. The actual sealing of the cable or pipe conduit is effected by pushing the parts of the SLIPSIL® multi-sealing plug between the ducted pipes and the wall of the conduit sleeve. Tooling, specially for the 4 and 5 holes plugs, is very expensive. For this reason we manufacture these only when larger series are to be supplied. Check the tables for availability.*

6-7	40/2x6-7	40.0921	54
6-7	41/2x6-7	40.1021	54
9-10	41/2x9-10	40.1024	54
10-11	41/2x10-11	40.1025	54
6-7	43/2x6-7	40.1131	54
6-7	43/3x6-7	40.1141	54
6-7	50/2x6-7	40.1231	66
7-8	50/2x7-8	40.1232	66
8-9	50/2x8-9	40.1233	66
9-10	50/2x9-10	40.1234	66
10-11	50/2x10-11	40.1235	66
12-13	50/2x12-13	40.1237	66
15-16	50/2x15-16	40.1240	66
7-8	53/2x7-8	40.1332	66
15-16	68/2x15-16	40.1938	66
16-17	68/2x16-17	40.1939	66
20-22	68/2x20-21	40.1943	66
22-24	68/2x22-23	40.1944	66
12-13	78/2x12-13	40.2240	66
13-14	80/2x13-14	40.2335	66
15-16	80/2x15-16	40.2337	66
16-17	80/2x16-17	40.2338	66
19-20	80/2x19-20	40.2340	66
22-23	80/2x22-23	40.2343	66
18-19	82/2x18-19	40.2439	66
22-24	82/2x22-23	40.2443	66
25-26	90/2x25-26	40.2544	66
6-7	41/3x6-7	40.1031	54
6-7	43/3x6-7	40.1141	54
6-7	50/3x6-7	40.1241	66
7-8	50/3x7-8	40.1242	66
14-15	78/3x14-15	40.2254	66
12-13	80/3x12-13	40.2352	66
15-16	80/3x15-16	40.2355	66
6-7	41/5x6-7	40.1037	54
5-6	55/5x5-6	40.1455	66
7-8	80/5x7-8	40.2367	66
12-13	80/5x12-13	40.2372	66
13-14	80/5x13-14	40.2373	66

**slipsil**



# SLIPSIL® SEALING PLUGS: HIGH-TECH NOFIRNO® TECHNOLOGY

## GAS AND WATER TIGHT CONDUITS: ABSOLUTELY ESSENTIAL

*It is self-evident that water leakages must be prevented under all circumstances. After all, leaking water means not only a nuisance but in most cases damage as well. Although no exact figures are known, it is safe to say that the corrosion damage caused every year by leaking cable and pipe entries runs into hundreds of millions of dollars. A great deal of effort therefore goes into minimizing the effects of water leakage. Preventing leaking conduits is an absolute must.*

If not, then the equipment installed in such areas will be attacked by the high level of relative humidity caused by leaking entries. Humidity even causes certain materials to start to decay. What is more, leaking entries can also allow gas to penetrate, leading to the potential threat of explosions.

**We can see the effects of leaks almost daily around us. However, we generally forget that a corrosion process is slowly but surely affecting the structure and equipment concerned.**

Secondary drawbacks are that moist spaces are generally accompanied by a mouldy atmosphere, fungus growth and a proliferation of vermin.

Open conduits in electrical installations offer rats and mice (attracted by the generally pleasant temperature) an easy opportunity to enter switching cabinets and rooms. All too often, this leads to short circuits.

Even more serious situations can occur if gas is able to penetrate into a crawl space through unsealed conduits, as a result of leaks in underground piping systems. An explosion, with all the resultant human suffering and material damage, may easily occur.

*It is therefore extremely important for all cable and pipe conduit openings in walls and floors to be effectively sealed, thereby keeping out moisture, gas, dust, fires, fumes and noise.*

Dust can enter installations through open cable and pipe conduits. This may lead to loss of functionality and defects in the equipment. However, dust explosions may also ultimately occur.

Condensation occurs where there are open cable and pipe conduits in walls between rooms with a large temperature difference. In the case of refrigerated and deep-freeze rooms this may lead to ice formation, ultimately leading to malfunctions and damage.

Another drawback of open conduits is that noise is transmitted from one room to another.

Even worse: there is also the danger that non-sealed conduits may allow fumes and flames to spread with extreme ease throughout the entire building in the event of fire.

Much can be done to prevent corrosion damage and gas explosions caused by leaking conduits. BEELE/CSD has specialized itself in this field, and has developed a large number of special-purpose products and systems.

BEELE/CSD has supplied gas and watertight conduit systems for cables and pipes ever since the company was founded in 1973.

**YOU KNOW, IF IT REALLY HAS TO BE  
ABSOLUTELY TIGHT ....  
IT'S BEST TO CALL IN THE PROFESSIONALS**

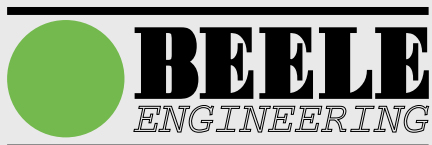

**YOUR RELIABLE  
PARTNERS**



# SLIPSIL® SEALING PLUGS: HIGH-TECH NOFIRNO® TECHNOLOGY

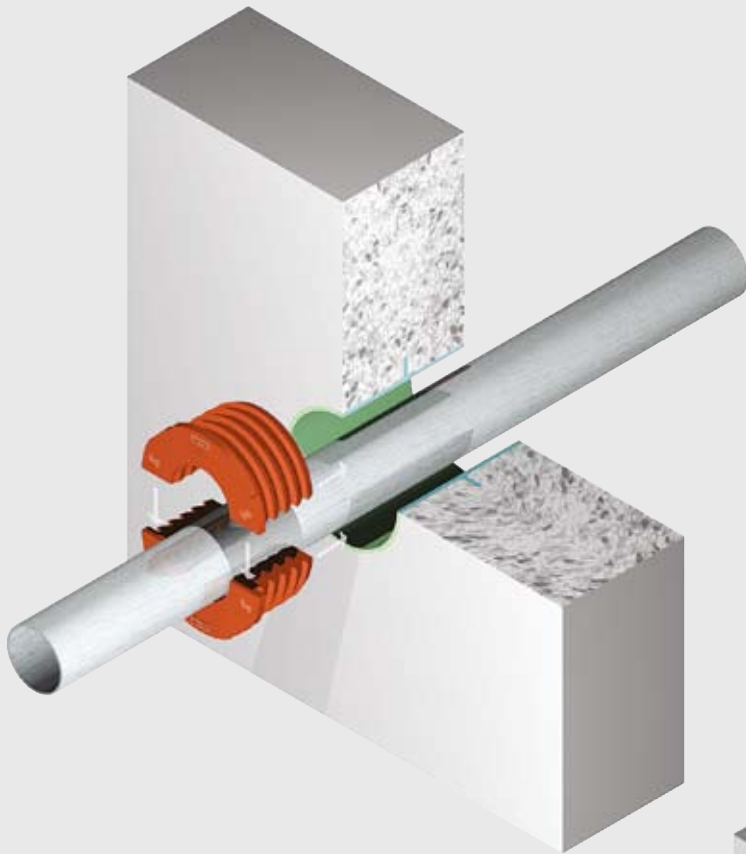

*Optimized gas and water tightness is obtained by using the SLIPSIL® sealing plugs in CSD® embedded or flanged pipes.*

*The sealing plugs also can be used in holes bored with diamond-tipped drills. The tolerances of the drilled hole should be within the tolerances of the plug series.*

*CSD® embedded pipes have a bonded-on or welded-on fixing collar in the middle to anchor the pipe in the concrete and also serve as a water barrier. See the specifications on pages 28 and 29.*



*For fire resistant seals, the sealing plugs must always be installed at each side of the conduit. For conduits which are required to be gas and water tight only, it is possible for a sealing plug to be installed at just one side of the conduit. Care should be taken that the ducted cable/pipe is not passed through the conduit opening at an angle.*

*In the case of required high sealing performance it is advisable to install plugs at each side of the conduit. This is a must anyway for penetrations through which pipes with an outside diameter larger than 75 mm are ducted.*

*For horizontal ducts it is extremely important to support the pipes properly at both sides of the conduit.*



# slipsil

# CSD EMBEDDED PIPES

**CSD® embedded pipes are pipes with a bonded-on or welded-on fixing collar (puddle flange). The collar serves as a water barrier and also anchors the pipe in the concrete. The CSD® embedded pipes were specifically developed to overcome the problems frequently encountered with fixing pipes effectively in concrete.**



PVC

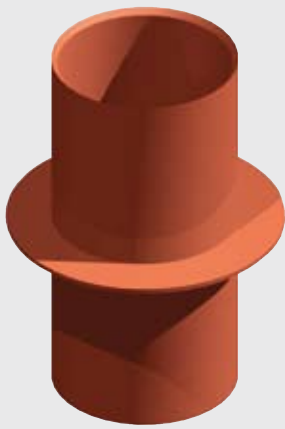

steel

surface treatment:  
red lead coated:  
type *stm*

surface treatment:  
hot dip galvanized:  
type *stg*

stainless steel 316:  
type *ss*

embedded pipe	plug series	embedded pipe	plug series
EM33pvc	34	EM37stm(g)	37
EM43pvc	43	EM54stm(g)	55
EM68pvc	68	EM82stm(g)	82
EM103pvc	103	EM107stm(g)	107
EM118pvc	118	EM131stm(g)	131
EM152pvc	152	EM159stm(g)	160
EM40ss	41		
EM60ss	60		
EM82ss	82		
EM100ss	100		
EM125ss	125		
EM150ss	150		

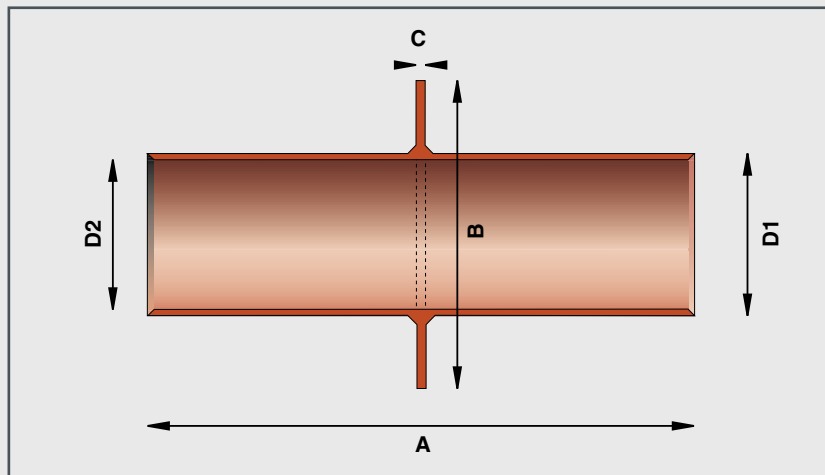

type	A	B	C	D1	D2	wall thickness	type	A	B	C	D1	D2	wall thickness
EM33pvc	300-400-500	80	3	40	33,6	3,2	EM37stg	200-300-400	122,4	5	42,4	37,2	2,6
EM43pvc	300-400-500	90	3	50	43,6	3,2	EM54stg	200-300-400	140,3	5	60,3	54,5	2,9
EM68pvc	300-400-500	125	3	75	68,6	3,2	EM82stg	200-300-400	168,9	5	88,9	82,5	3,2
EM103pvc	300-400-500	170	3	110	103,6	3,2	EM107stg	200-300-400	194,3	5	114,3	107,1	3,6
EM118pvc	300-400-500	185	3	125	118,6	3,2	EM131stg	200-300-400	219,7	5	139,7	131,7	4,0
EM152pvc	300-400-500	230	3	160	152	4,0	EM159stg	200-300-400	248,3	5	168,3	159,3	4,5
type	A	B	C	D1	D2	wall thickness	type	A	B	C	D1	D2	wall thickness
EM37stm	200-300-400	122,4	5	42,4	37,2	2,6	EM40ss	200-300-400	120	5	43	40	1,5
EM54stm	200-300-400	140,3	5	60,3	54,5	2,9	EM60ss	200-300-400	140	5	63,5	60	1,75
EM82stm	200-300-400	168,9	5	88,9	82,5	3,2	EM82ss	200-300-400	162,5	5	88,9	82,5	3,2
EM107stm	200-300-400	194,3	5	114,3	107,1	3,6	EM100ss	200-300-400	180	5	106	100	3,0
EM131stm	200-300-400	219,7	5	139,7	131,7	4,0	EM125ss	200-300-400	205	5	133	125	4,0
EM159stm	200-300-400	248,3	5	168,3	159,3	4,5	EM150ss	200-300-400	230	5	156	150	3,0

All dimensions in mm - When ordering, please state the length needed. Non-standard lengths can be supplied to order.

# CSD FLANGED CONDUIT PIPES

CSD® steel flanged pipes have a welded-on flange at the end. The flange has a number of attachment holes. The flanged pipes are secured against the wall or on the floor by means of steel anchoring bolts. Between the flanged pipe and the structure, a gasket made of NOFIRNO® fire resistant rubber is applied.



surface treatment:  
red lead coated:  
type *stm*

stainless steel 316:  
type *ss*

surface treatment:  
hot dip galvanized:  
type *stg*

flanged pipe	plug series	flanged pipe	plug series
EM37stm(g)	37	EM40ss	41
EM54stm(g)	55	EM60ss	60
EM82stm(g)	82	EM82ss	82
EM107stm(g)	107	EM100ss	100
EM131stm(g)	131	EM125ss	125
EM159stm(g)	160	EM150ss	150

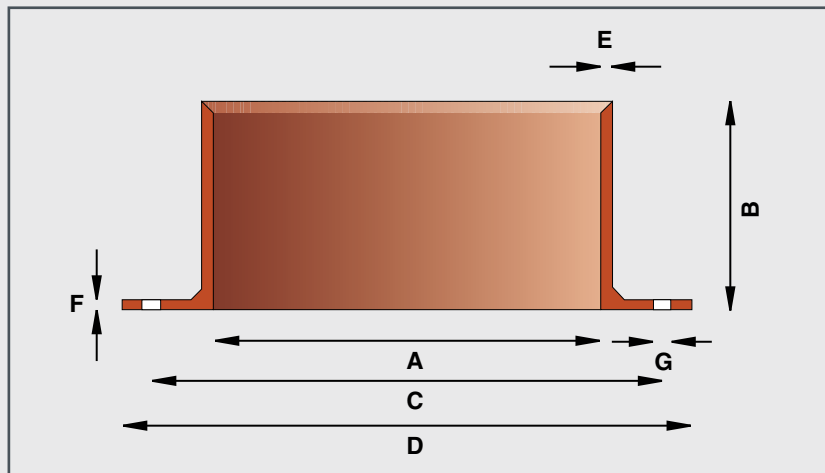

type	A	B	C	D	E	F	G	number G	type	A	B	C	D	E	F	G	number G
FB37stg	37,2	75	87,2	117,2	2,6	5	9	4	FB37stm	37,2	75	87,2	117,2	2,6	5	9	4
FB54stg	54,5	75	104,5	134,5	2,9	5	9	4	FB54stm	54,5	75	104,5	134,5	2,9	5	9	4
FB82stg	82,5	75	132,5	162,5	3,2	5	9	6	FB82stm	82,5	75	132,5	162,5	3,2	5	9	6
FB107stg	107,1	75	157,1	187,1	3,6	5	9	8	FB107stm	107,1	75	157,1	187,1	3,6	5	9	8
FB131stg	131,7	75	181,7	211,7	4,0	5	9	8	FB131stm	131,7	75	181,7	211,7	4,0	5	9	8
FB159stg	159,3	75	209,3	239,3	4,5	5	9	8	FB159stm	159,3	75	209,3	239,3	4,5	5	9	8

type	A	B	C	D	E	F	G	number G	stg/stm	ss	GASKETS
FB40ss	40	75	90	120	1,5	5	9	4	HFS37	HFS40	NOFIRNO® gaskets are used to obtain a seal between the wall or floor and the CSD® flanged pipe. The gaskets are made from the same NOFIRNO® fire resistant rubber as used for the SLIPSIL® sealing plugs.
FB60ss	60	75	110	140	1,75	5	9	4	HFS54	HFS60	
FB82ss	82,5	75	132,5	162,5	3,2	5	9	6	HFS82	HFS82	
FB100ss	100	75	150	180	3,0	5	9	8	HFS107	HFS100	
FB125ss	125	75	175	205	4,0	5	9	8	HFS131	HFS125	
FB150ss	150	75	200	230	3,0	5	9	8	HFS159	HFS150	

All dimensions in mm

# SLIPSIL® SEALING PLUGS: HIGH-TECH NOFIRNO® TECHNOLOGY

1) Before starting the installation procedure, any dirt or concrete and oil residues should be removed from the conduit opening (PVC or steel embedded pipe or drilled hole).

**slipsil**

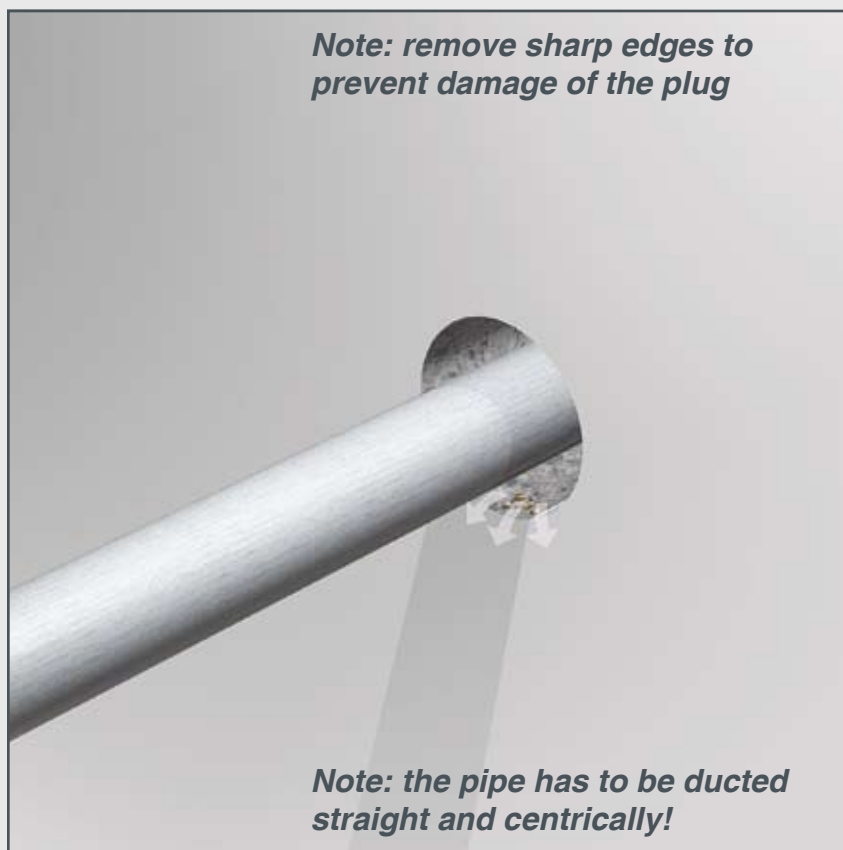

**CSD**

2) Then the inside wall of the conduit opening is treated with CSD® lubricant along a distance which approximately corresponds with the length of the SLIPSIL® sealing plug.

**slipsil**





# SLIPSIL® SEALING PLUGS: HIGH-TECH NOFIRNO® TECHNOLOGY

3) The inside surfaces of both segments of the SLIPSIL® sealing plug are then treated with CSD® lubricant.

*For selecting the right sealing plug, look for the plug series and the plug type in this series on the basis of the ID of the sleeve and the OD of the ducted pipe.*

# slipsil



# CSD

4) The segments of the SLIPSIL® sealing plug are also treated with CSD® lubricant on the outside.

*Please refer to the Safety Data Sheet of the CSD® lubricant for more information.*

# slipsil



# SLIPSIL® SEALING PLUGS: HIGH-TECH NOFIRNO® TECHNOLOGY

5) Both segments of the SLIPSIL® sealing plug are placed around the ducted pipe and then pushed into the conduit opening as far as the first serration.

The first serration is smaller than the other serrations to make this procedure very easy.

**slipsil**

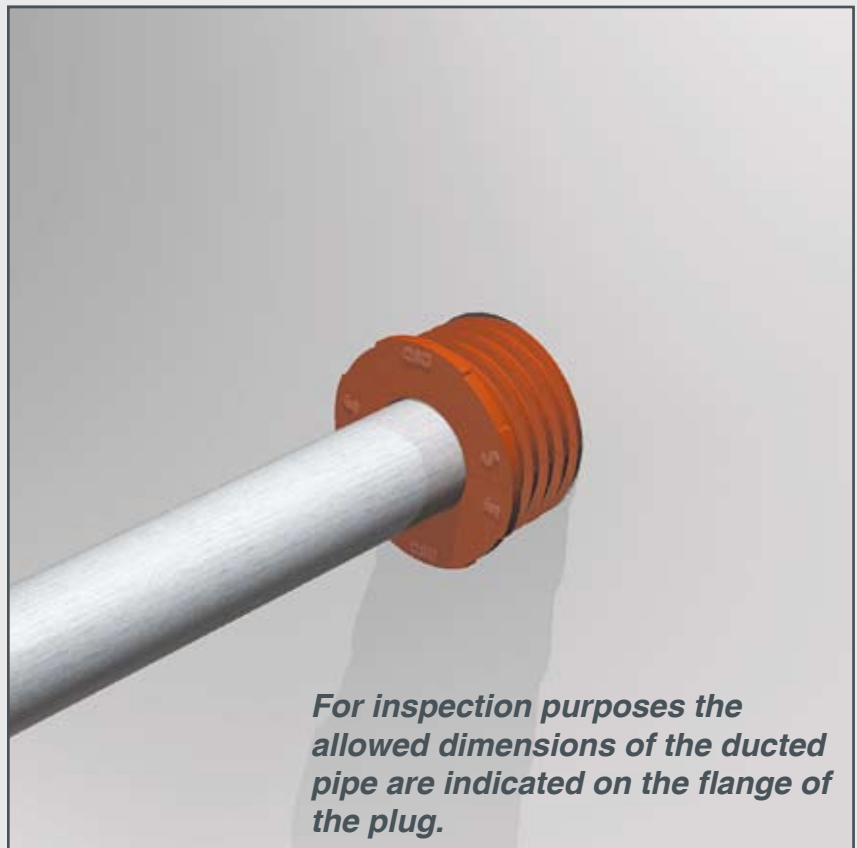

**CSA**

6) Then both segments of the SLIPSIL® sealing plug are pushed by hand evenly, serration by serration, further into the conduit opening.

Extremely thin plugs or plugs applied in undersized conduits with oversized service pipes, can be tapped in using a hammer and a piece of wood.

**slipsil**



# SLIPSIL® SEALING PLUGS: HIGH-TECH NOFIRNO® TECHNOLOGY

7) The flanged edge of the sealing plug must be flush against the wall or floor.

*Not only the right choice of the sealing plug, but also proper installation is a determining factor for the degree of tightness of the sealing plugs.*

**slipsil**

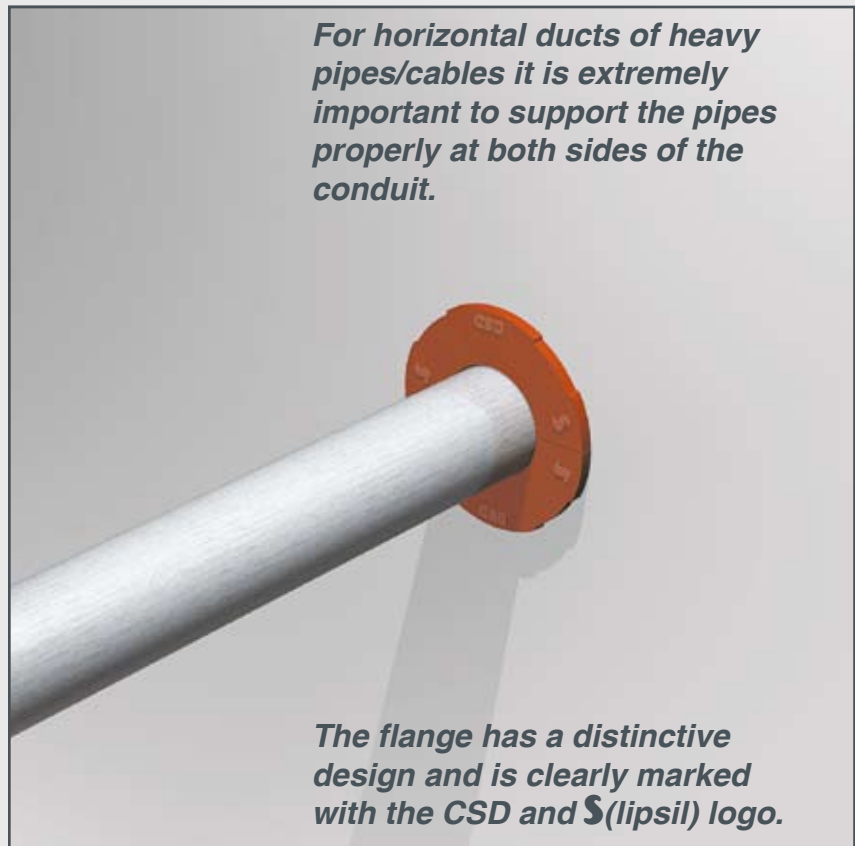

**CSD**

8) For fire rated penetrations SLIPSIL® sealing plugs have to be inserted in both ends of the conduit. This is also a must for watertight penetrations. To enable insertion of the sealing plugs from one side the SLIPSIL®/ DYNATITE® combination can be used.

**slipsil**

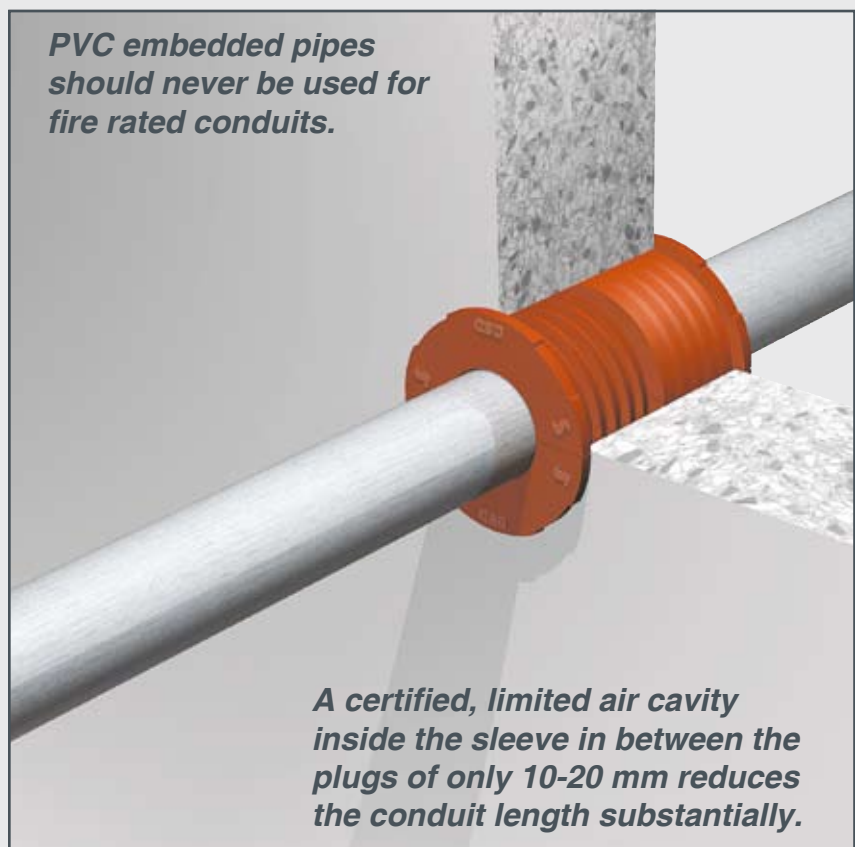

# SLIPSIL® SEALING PLUGS: HIGH-TECH NOFIRNO® TECHNOLOGY

Plastic pipes which pass through fire-rated walls and floors as part of, for example, sanitation systems, are a potential source of serious problems in case of fire. Most plastic pipes start to soften at a temperature of about 75 °C and ignite at a temperature of about 140 °C. This means that, should a fire occur, a hole will be formed by the softened or combusted plastic pipe, allowing fumes and flames to spread freely. To meet this problem, BEELE Engineering has developed the crusher SLIPSIL® plug system.

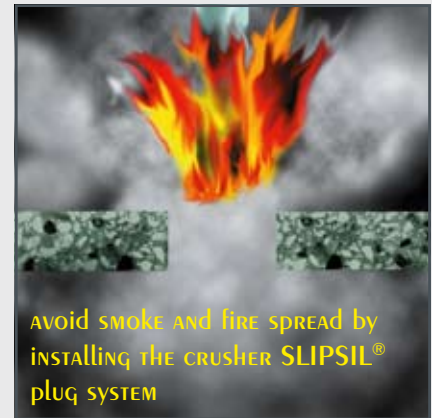
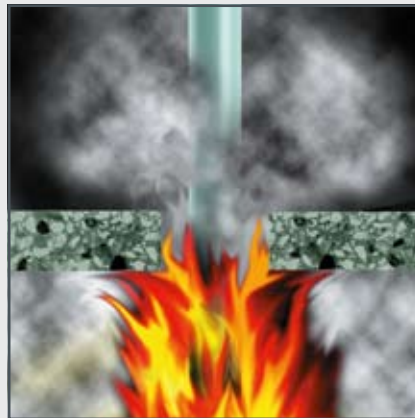
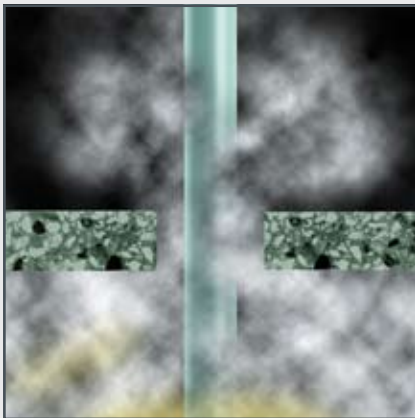

AVOID SMOKE AND FIRE SPREAD by  
INSTALLING THE CRUSHER SLIPSIL®  
plug SYSTEM

For this purpose use is made of RISE® rubber (type FRR-EHF = fire resistant rubber - expanding, halogen free). This rubber is placed between SLIPSIL® sealing plugs made of NOFIRNO® rubber.

When exposed to temperatures above 200 °C or flames, RISE® rubber will expand vigorously to more than ten times its original volume with such a force that even a thin wall aluminium pipe will be crushed. This means that in case of a fire no opening will be left in the conduit for the passage of smoke and flames.

Specially for plastic pipes the cavity between both SLIPSIL® plugs needs to be partly filled with RISE® rubber strips or sleeves. Other than with

PE/ALU pipes the time to close off the opening left by the burned or softened plastic pipe is very short. If the reaction is too late, a chimney effect will occur causing the pipe at the unexposed side to melt.

RISE® rubber will expand as soon as the conduit sleeve is subjected to heat and as a result it will in a very short time seal off the opening created by the softened or combusted plastic pipe.

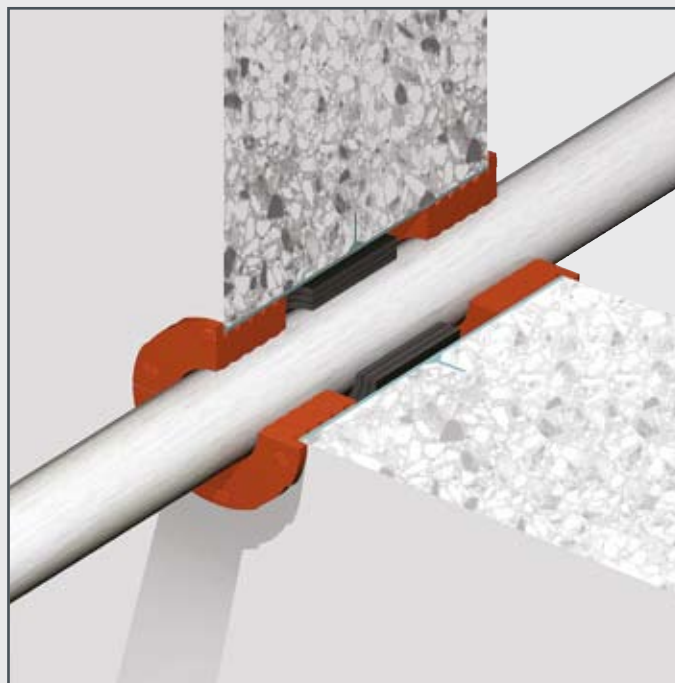

The expanded RISE® rubber possesses good thermal insulation properties, ensuring that the softened pipe will reharden after compression. NOFIRNO® rubber will form a char at the front side of the SLIPSIL® plug at the exposed side and will slightly expand. In this way the RISE® rubber is fully enclosed and can only expand in the direction of the softened plastic pipe. The SLIPSIL® plug at the unexposed side will keep the penetration smoke tight during the fire. The

crusher SLIPSIL® plug system is a push-in system and requires no complicated installation work. Firesafe, gas and water tight.

See also the RISE®/ULTRA brochure.

# CRUSHER®

# SLIPSIL® SEALING PLUGS: HIGH-TECH NOFIRNO® TECHNOLOGY

## DIAGRAMMATIC OVERVIEW OF ONSHORE APPLICATIONS

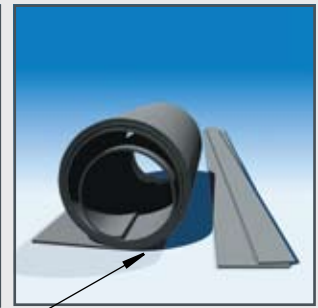
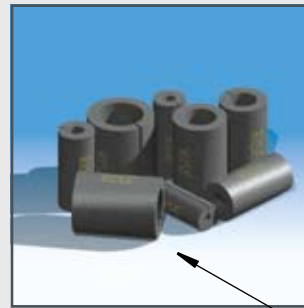
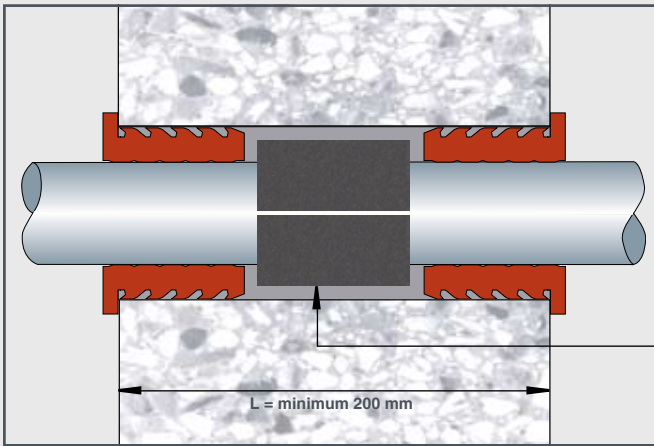

80 mm wide strips of RISE® (FRR/EHF) rubber wrapped around the ducted plastic pipe in a thickness  $1/4 \times D$  of the ducted pipe, rounded off to  $\pm 5$  mm. For pipe sizes up to 42 mm insert sleeves are available in a length of 80 mm with the required wall thickness as an alternative for wrapping the strips around these pipes. Available sizes: 12/6, 12/8, 16/10, 18/12, 22/14, 27/16, 27/18, 31/20, 35/22, 39/24, 39/26, 46/28, 46/30, 52/32, 52/34, 58/36, 58/38, 64/40 and 64/42.

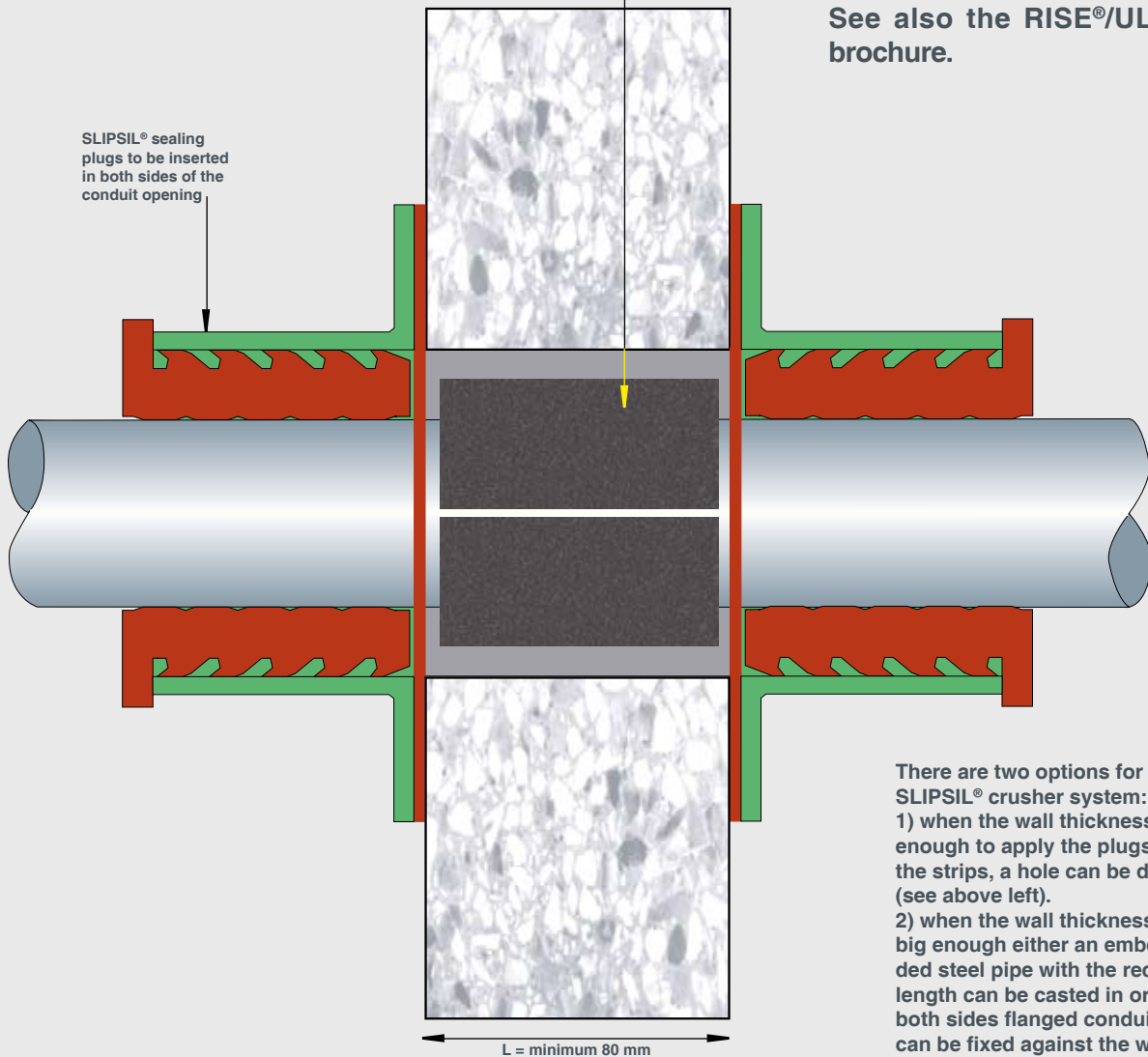

See also the RISE®/ULTRA brochure.

There are two options for the SLIPSIL® crusher system:  
1) when the wall thickness is big enough to apply the plugs and the strips, a hole can be drilled (see above left).  
2) when the wall thickness is not big enough either an embedded steel pipe with the required length can be casted in or on both sides flanged conduit pipes can be fixed against the wall.

# CRUSHER®

# THE FIRST PHASE OF THE NEW FACTORY NEXT TO OUR R&D CENTRE



- 1) machines specially developed for compounding and processing of rubbers under controlled conditions to obtain optimum quality
- 2) machines specially developed for compounding and manufacturing of all types of sealants under controlled processing
- 3) moisture treatment installation and processing equipment for manufacturing of electrically conductive sealants and rubbers
- 4) a complete line of injection moulding presses ranging from 40 tons up to 400 tons for manufacturing sealing plugs and other rubber components
- 5) a complete line of compression moulding presses up to 300 tons for manufacturing larger type sealing plugs and ULEPSI rubber plates
- 6) processing installation for after-curing of rubber products to obtain the required compression set (long term behaviour)
- 7) extruder line including cooling system and cutting and slitting installation for manufacturing insert and filler sleeves for the RISWAT system
- 8) fully automatic extruder lines with a length of 20 meters, including cooling system and automatic cutting, slitting and sorting installation for manufacturing rubber insert and filler sleeves and rubber strips of the RISE system
- 9) extruder line for manufacturing luminescent profiles and hoses
- 10) line of injection moulding machines ranging from 50 up to 200 tons for manufacturing plates of the ULEPSI tank supports and luminescent YFESTOS floor coverings
- 11) completely equipped die-making shop for the in-house production of all tooling for rubber and plastics manufacturing
- 12) modern laser equipment for engraving the type codes in the dyes for rubber manufacturing and for marking products with bar and 2D-matrix codes
- 13) mixing and airless spraying facilities for the NOFIRNO boards

*Together with highly advanced systems and technologies  
we offer highest quality products.*

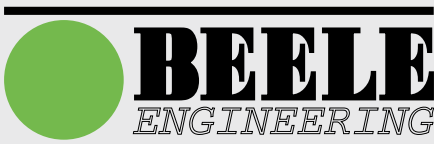

**YOUR RELIABLE  
PARTNERS**





# **MAXIMUM SIMPLICITY OF USE OPTIMUM FLEXIBILITY OUTSTANDING PERFORMANCE**

Websites: <http://www.actifoam.com>, [www.beele.com](http://www.beele.com), [www.firsto.com](http://www.firsto.com), [www.nofirno.com](http://www.nofirno.com),  
[www.rise-systems.com](http://www.rise-systems.com), [www.rise-nofirno.com](http://www.rise-nofirno.com), [www.riswat.com](http://www.riswat.com) and [www.slipsil.com](http://www.slipsil.com)

## **ASK FOR THE SEPARATE BROCHURES ON OUR PRODUCT RANGES:**

- \* **RISE<sup>®</sup> MULTI-CABLE TRANSIT SYSTEM**
- \* **RISE<sup>®</sup> SEALING SYSTEM FOR SINGLE AND MULTI-PIPE PENETRATIONS**
- \* **RIACNOF<sup>®</sup> MULTI-CABLE TRANSIT SYSTEM**
- \* **RISE<sup>®</sup>/NOFIRNO<sup>®</sup> MULTI-ALL-MIX CABLE AND PIPE TRANSITS**
- \* **RISE<sup>®</sup>-ULTRA SINGLE PLASTIC PIPE PENETRATIONS**
- \* **RISWAT<sup>®</sup> GAS AND WATERTIGHT CABLE AND PIPE DUCTS**
- \* **SLIPSIL<sup>®</sup> SEALING PLUGS FOR PIPE ENTRIES**
- \* **SLIPSIL<sup>®</sup>-SQ MULTI-CABLE TRANSITS**
- \* **DYNATITE<sup>®</sup> DYNAMIC HIGH PRESSURE SEALS**
- \* **BEESEAL<sup>®</sup> MULTI-PIPE AND CABLE PENETRATIONS**
- \* **ACTIFOAM<sup>®</sup> TEMPORARY SEALS AND CAVITY SEALS**
- \* **FIRSTO<sup>®</sup> FIRESTOPS FOR CABLE TRAY PENETRATIONS**
- \* **NOFIRNO<sup>®</sup> CAVITY SEALS, COATINGS AND SEALANTS**
- \* **ULEPSI<sup>®</sup> TANK SUPPORTS FOR BITUMEN TANKERS**



**CONDUIT SEALING DEVICES OF AN  
AMAZING SIMPLICITY WITH AN  
OUTSTANDING PERFORMANCE**

**slipsil**

*BEELE Engineering and CSD International have been involved with fire, water and gas tight sealing for more than 30 years. We have developed and tested products proven to provide the utmost in sealing protection around the world. To receive our complete civil construction and/or marine products catalogues, please contact your distributor or local representative.*

distributed by:

**CSD Sealing Systems - North America**  
21 Meadowbrook Lane, Unit 12, Bayview Business Park  
GILFORD, NH 03249  
Tel. (603) 293-0100 - Fax (603) 293-0200  
[www.csd.us.com](http://www.csd.us.com) - E-mail: [info@csd.us.com](mailto:info@csd.us.com)